



This is a digital copy of a book that was preserved for generations on library shelves before it was carefully scanned by Google as part of a project to make the world's books discoverable online.

It has survived long enough for the copyright to expire and the book to enter the public domain. A public domain book is one that was never subject to copyright or whose legal copyright term has expired. Whether a book is in the public domain may vary country to country. Public domain books are our gateways to the past, representing a wealth of history, culture and knowledge that's often difficult to discover.

Marks, notations and other marginalia present in the original volume will appear in this file - a reminder of this book's long journey from the publisher to a library and finally to you.

### **Usage guidelines**

Google is proud to partner with libraries to digitize public domain materials and make them widely accessible. Public domain books belong to the public and we are merely their custodians. Nevertheless, this work is expensive, so in order to keep providing this resource, we have taken steps to prevent abuse by commercial parties, including placing technical restrictions on automated querying.

We also ask that you:

- + *Make non-commercial use of the files* We designed Google Book Search for use by individuals, and we request that you use these files for personal, non-commercial purposes.
- + *Refrain from automated querying* Do not send automated queries of any sort to Google's system: If you are conducting research on machine translation, optical character recognition or other areas where access to a large amount of text is helpful, please contact us. We encourage the use of public domain materials for these purposes and may be able to help.
- + *Maintain attribution* The Google "watermark" you see on each file is essential for informing people about this project and helping them find additional materials through Google Book Search. Please do not remove it.
- + *Keep it legal* Whatever your use, remember that you are responsible for ensuring that what you are doing is legal. Do not assume that just because we believe a book is in the public domain for users in the United States, that the work is also in the public domain for users in other countries. Whether a book is still in copyright varies from country to country, and we can't offer guidance on whether any specific use of any specific book is allowed. Please do not assume that a book's appearance in Google Book Search means it can be used in any manner anywhere in the world. Copyright infringement liability can be quite severe.

### **About Google Book Search**

Google's mission is to organize the world's information and to make it universally accessible and useful. Google Book Search helps readers discover the world's books while helping authors and publishers reach new audiences. You can search through the full text of this book on the web at <http://books.google.com/>

N2-A5







**Library**  
of the  
**University of Wisconsin**

N2-A5











# THE ANOMALOUS DISPERSION OF CYANIN

BY

CARL EDWARD MAGNUSSON, B. E. E., M. S.

A THESIS SUBMITTED FOR THE DEGREE OF DOCTOR OF PHILOSOPHY,  
UNIVERSITY OF WISCONSIN, 1900

(Reprinted from the Bulletin of the University of Wisconsin, Science Series,  
Vol. 2, No. 4, pp. 247-296)

MADISON, WISCONSIN

JULY, 1900



BULLETIN OF THE UNIVERSITY OF WISCONSIN

NO. 41

SCIENCE SERIES, VOL. 2, NO. 4, PP. 247-296, PLATES 16-22

---

THE ANOMALOUS DISPERSION OF CYANIN

BY

CARL EDWARD MAGNUSSON, PH. D.

*Fellow in Physics*

*Published bi-monthly by authority of law with the approval of the Regents  
of the University and entered at the post office at  
Madison as second-class matter*

MADISON, WISCONSIN

JULY, 1900

## CONTENTS.

---

	PAGE
<b>PART I. HISTORICAL SURVEY.</b>	
(a) <i>Experimental.</i> . . . . .	249
(b) <i>Theoretical.</i> . . . . .	258
<b>PART II. EXPERIMENTAL WORK.</b>	
Introduction. . . . .	268
(a) The Visible Part of the Spectrum. . . . .	269
(b) Investigations in the Ultra Violet . . . . .	274
(c) The Method of Crossed Prisms. . . . .	277
(d) The Interferometer Method. . . . .	279
Conclusion. . . . .	287
<b>BIBLIOGRAPHY..</b> . . . .	288



AW  
M275

398490  
OCT - 4/1933  
IWZX  
M275

# THE ANOMALOUS DISPERSION OF CYANIN.

---

## PART I.

### HISTORICAL SURVEY.

(a) *Experimental.*—It has long been a well known fact that prisms having the same angle of refraction, but made of different kinds of glass, yield spectra which are wholly unlike one another in character. Not only is the refraction or the deviation of the light produced by one prism different from that which results when a prism of different material is employed, but the amount of dispersion, or the angular extent of the spectrum, depends likewise upon the material of which the refracting substance is composed. Moreover, to a very great extent, refraction and dispersion are independent of each other, so that media are frequently found having a high refractive index but a small dispersive power, and conversely, other media exist having small refractive power but possessing high dispersion. The angular distance between any two given wave lengths in the prismatic spectrum depends, therefore, not only upon the refracting angle of the prism but upon the nature of the material of which the prism is made, so that in general, prismatic spectra are unlike one another both in angular extent and in angular distance between corresponding wave lengths. This variability in the character of prismatic spectra is known as the irrationality of dispersion.

Until the year 1840 no exception had been found to the general law that short waves are deviated more than longer ones, that is to say, that the order of arrangement of colors in the spectrum is always the same although the distances between any

two given wave lengths may vary considerably. At about this time Fox Talbot, while working with the double oxalate of chromium and potash, made the remarkable discovery that prismatic crystals of this substance have the power of deviating the red more than the blue. Nothing was published on the subject, however, until nearly twenty years later, when Le Roux<sup>1</sup> announced the fact that by a hollow glass prism filled with iodine vapors the red rays are bent more than the blue. Talbot<sup>2</sup> at once recalled his early experiments and published an account of what he had done. Speaking of the arrangement of the colors in the spectrum produced by the double oxalate of chromium and potash, he says: "The colors were very anomalous, and after making many experiments I came to the conclusion that they could only be explained by the supposition that the spectrum, after proceeding for a certain distance, stopped short and returned upon itself."

M. Hurion<sup>3</sup> made quantitative measurements upon iodine vapors and found the refractive index for the violet and red rays at 700° C to be  $\mu_v=1.019$ ;  $\mu_r=1.0205$ .

The first real impulse for extensive work upon this phenomenon was given by Christiansen<sup>4</sup> in 1870, when he discovered anomalous dispersion in an alcoholic solution of fuchsin. Christiansen noticed that in the transmitted beam the green light was absent, that the red, orange, and yellow rays were refracted in their usual order, but that the violet was deviated less than the red, so that a dark band lay between it and the red.



FIG. 1.

The relative arrangement of the colors in this spectrum is shown in figure 1, in which the approximate intensities of the

<sup>1</sup> Le Roux, *Comp. Rend.*, LV., p. 126 (1862). *Pogg. Ann.* CXVII., p. 659; *Ann. de Chim. et de Phys.* (3) LXL., p. 285 (1861).

<sup>2</sup> Talbot, *Proc. Roy. Soc. Edin.* 1870-1871.

<sup>3</sup> M. Hurion, *Jour. de Phys.* (1), VII., p. 181.

<sup>4</sup> Christiansen, *Pogg. Ann.* CXXI., p. 479; CXLIII., p. 250; CXLVI., p. 154.

light are represented by the height of the respective ordinates. The great dispersive power of fuchsin became at once apparent on comparing lengths of the spectra produced by the dye and by pure alcohol, that due to the latter being represented by the dotted lines in the figure. For an 18 per cent. solution of fuchsin in alcohol, Christiansen obtained the following indices of refraction:

TABLE I.

Fraunhofer Lines.	B.	C.	D.	E.	F.	G.	H.
18 per cent. Fuchsin solution....	1.450	1.502	1.561	.....	1.313	1.268	1.312
Pure alcohol.....	1.3628	.....	1.3654	1.3675	1.3696	1.3733	1.3761

He worked with solutions of different concentrations and showed that the refractive index increases with the density of the solution, but that this increase is different for the various wave lengths.

When Christiansen published his first results the subject was taken up very energetically by Kundt,<sup>1</sup> who repeated the work on fuchsin and examined many of the aniline dyes and other colored solutions, such as indigo, carmine, and potassium permanganate. Many of these substances show "surface color," that is, they have the power of reflecting certain colors more than others. Kundt made extensive experiments to show the interdependence of the two phenomena and came to the conclusion that all substances which show "surface color" also give anomalous spectra. Continuing his experiments he found that a very close relation exists between dispersion and absorption, and that anomalous dispersion depends upon the selective absorption of the medium and not upon the "surface color." This discovery of the relation between absorption and dispersion has been of the greatest importance and has enabled later investigators to contribute much to our knowledge of dispersion. Kundt embodied his conclusions in the following statement, which is known as Kundt's Law,<sup>2</sup> to which no exception has as

<sup>1</sup> Kundt, Pogg. Ann. CXLII., p. 163; CXLIII., pp. 149, 259; CXLIV., p. 128; CXLV., pp. 67, 164.

<sup>2</sup> Kundt, Pogg. Ann. CXLIII., p. 265.



yet been found: "Coming from the red end of the spectrum and approaching an absorption band the refractive index is abnormally increased, and coming from the violet end towards the absorption band the refractive index is abnormally decreased."

To make the peculiar variations in the refractive index directly visible to the eye, Kundt employed the method of crossed prisms<sup>1</sup> as first used by Newton<sup>2</sup> in ordinary dispersion. A beam of white light is first dispersed by a glass prism placed with its refracting edge vertical. This spectrum is then passed through a hollow prism filled with an alcoholic solution of cyanin and placed with its refracting edge horizontal. Thus the prisms have their refracting edges at right angles to each other so that the first one deviates the light in a horizontal plane while the second bends the rays in a vertical direction. Suppose the deviation is simply inversely proportional to the wave length, that is, a normal spectrum, such as is produced by a grating, in each case, the resulting crossed prism spectrum will become a diagonal band having the violet end elevated. This is seen in (a), Fig. 2. The lower band shows the appearance of the spectrum produced by the first prism only, while

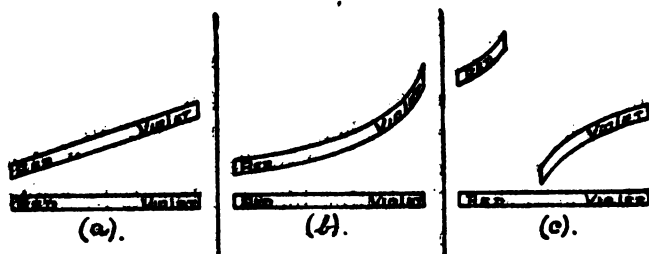

FIG. 2.

the diagonal band represents the final result after passing through both prisms. If now the dispersion of the second prism was irrational, as is the case with ordinary glass, the final result would be a curved band as is seen in the upper part of (b), Fig. 2. If the common glass prism is removed and a hollow prism filled with a cyanin solution, as used by Kundt,

<sup>1</sup> Kundt, Pogg. Ann. CXLIV., p. 133.

<sup>2</sup> Newton's Opticks, Book I, Prop. II.

is placed in the second position, the crossed prism spectrum will be broken into two bands as is seen in (c), Fig. 2. The red is deviated very much and the band turns up sharply as the orange is approached; the yellow is absorbed, and hence, absent, leaving the spectrum in two parts; the green is bent least, while the deviation rapidly increases as the violet is approached. This method is very striking to the eye and gives an easy means of determining roughly the nature of a spectrum.

With the dye in solution and placed in a common hollow prism, the deviation produced by the solvent is superimposed upon that made by the dye itself. To separate the two, Soret<sup>1</sup> made a glass trough with parallel sides, having a diagonal glass partition. On one side he poured the solution and on the other the pure solvent. Consequently, any deviation in the light was due to the dissolved substance only and not to the solvent. Still, it must be noted that a substance when dissolved may not have the same optical properties as when in the solid state. For the same purpose DeKlercker<sup>2</sup> used two hollow prisms of the same angle and placed in opposite directions, the one being filled with the solution and the other with the solvent.

Quantitative measurements, by the ordinary spectrometer method, for determining the refractive index for various wave lengths have been carried out by several physicists. Sieben<sup>3</sup> and Ketteler<sup>4</sup> in particular made a large number of observations upon various substances, in several solvents, and at different temperatures and concentrations. Among the solvents used were alcohol, chloroform, and water. Their aim was to make experimental observations upon which they could base a theory that would explain this strange phenomenon. This experimental data was afterwards used by Ketteler in his theoretical deductions and some important results were reached. Still, it cannot be said that he succeeded in establishing the theory advanced, inasmuch as it is evident that a substance in solution

---

<sup>1</sup> Soret, Pogg. Ann. CXLIII., p. 325, (1871).

<sup>2</sup> DeKlercker, Comp. Rend. LXXXIX. (1879).

<sup>3</sup> Sieben, Wied. Ann. VIII., p. 137; XXIII., p. 312.

<sup>4</sup> Ketteler, *ibid.* XII., pp. 363, 481.

may have entirely different optical properties from those which it possesses in a solid state.

To avoid this objection several indirect methods based upon the properties of the solid dye were devised. The results obtained do not warrant a detailed description, but a bare statement of the methods used will be made. Sieben employs a method based on the total reflection of light from the surface of the solid dye. By measuring the absorption of the solid dye for various wave lengths, Wernicke<sup>1</sup> was able to calculate the index of refraction, and for fuchsin his results are given in Table II.

TABLE II.

$\lambda$	581	571	532	483	466	436	438
$\mu$	2.326	2.372	1.875	1.530	1.288	1.224	1.206

Wiedemann,<sup>2</sup> Lundquist,<sup>3</sup> and Merkel<sup>4</sup> made observations to determine the elliptic polarization of the light reflected from the surface of the solid substance. The work of these and several other observers, although of great interest, is so dependent upon a number of doubtful assumptions that to show the real value of the results a detailed description must be made. The latter is outside the limit of a brief outline and must be omitted. Although the refractive index, and therefore, also, the velocity of the light in the substance can be calculated by these indirect methods, still, the direct observation of refraction by a solid prism is by far the simplest and surest procedure. As early as 1875 Wernicke<sup>5</sup> determined the indices given in Table III., by means of a prism of solid fuchsin.

TABLE III.

Fraunhofer lines.	A.	B.	C.	G.	H.
$\mu$	1.731	1.81	1.90	1.31	1.54

<sup>1</sup> Wernicke, Pogg. Ann. CLV., p. 87.

<sup>2</sup> Wiedemann, *ibid.* CLL., p. 1, (1874).

<sup>3</sup> Lundquist, *ibid.* CLIL., pp. 177, 398, 565, (1874).

<sup>4</sup> Merkel, Nov. Act. Roy. Soc. Upsala, Ser. III.

<sup>5</sup> Wernicke, Pogg. Ann. CLV., p. 93, (1875).

It appears that only one prism was made and that was far from being satisfactory, for in speaking of the results Wernicke says that the A and B lines were "plain," the rest "uncertain." The D, E, and F lines could not be determined as the prism absorbed all the light in this part of the spectrum.

It was almost twenty years later that Pfüger<sup>1</sup> succeeded in making solid prisms of several of the aniline dyes. The method of making the prisms is as follows: A piece of glass tubing is laid upon a piece of plate glass, and in the prismatic opening between the two an alcoholic solution of the dye is placed, drop by drop, and allowed to evaporate. The solid dye will thus fill up the prismatic space between the tube and the plate. When the deposit is of the desired thickness, the process is stopped, the glass tube removed by a sharp blow, and a small bi-prism is thus left on the glass plate. This is simple in theory but tedious in practice. To secure three good prisms Pfüger<sup>2</sup> made over three hundred attempts, and still even the best had optically poor surfaces. Since the angles of the prisms used by Pfüger were very small, the largest being  $2' 9''.6$ , the irregularities in the surface became serious sources of error, inasmuch as a small error in measuring the angle of the prism produces a large percentage error in the results. With solid prisms of several of the aniline dyes, formed in this manner, Pfüger determined the refractive indices, for the visible part of the spectrum, by the usual direct spectrometer method.

Fuchsin and cyanin received the most attention and the average results obtained by four prisms of the latter are given in Table IV.<sup>3</sup>

TABLE IV.

$\lambda$	700	671	656	645	620	589	565	540	535	520	505	486
$\mu$	2.05	2.13	2.19	2.23	1.94	1.71	1.39	1.25	1.20	1.19	1.23	1.40

With cyanin he extended his experiments into the ultra violet. To do this he used an iron arc spectrum, dispersed by a

<sup>1</sup> Pfüger, *Wied. Ann.* LVI., p. 412, (1895); LXV., pp. 173, 214, 225, (1898).

<sup>2</sup> Pfüger, *ibid.* LXV., p. 205, (1898).

<sup>3</sup> Pfüger, *ibid.*, p. 206.

Rowland's concave grating. Between the grating and its focus he placed the small cyanin biprism with its refracting edge parallel to the lines of the grating. The double set of bright lines thus formed at the focus were photographed. The distance between the corresponding lines in the two sets were measured and from these measurements the refractive indices were calculated. These results are given in the following table:

TABLE V.

Prism.	$\alpha$	438	407	405	378	350	288
1	83°			1.70		1.70	1.71
0	126.4	1.59	1.68		1.69		
Mean $\mu$		1.59	1.68	1.70	1.69	1.70	1.71

The objective point of Pfüger's work was to test the Ketteler-Helmholtz dispersion formula, the derivation and form of which will be given in the theoretical part of this paper. The equations require experimental data for both the extinction and refraction indices. To find the former, Pfüger employed a König's spectro-photometer, by which the absorption of the light, when passing through a thin film of cyanin, was measured. The ratio between the original intensity,  $I$ , and the strength after passing through the film  $I'$ , is found by equation (1), where  $\alpha$  is given by the reading of the photometer.

$$\frac{I}{I'} = \text{Cot } \alpha^2 \quad (1).$$

The extinction index,  $X$ , is then calculated by the usual formula, (2), where  $d$  is the thickness of the film,  $\lambda$  the wave length of the light in free space, and  $e$  the base of the natural system of logarithms.

$$\frac{I}{I'} = e^{-\frac{4\pi Xd}{\lambda}} \quad (2).$$

In the series of papers published by Pfüger are found several tables for the extinction index. The disagreement between the calculated and observed values led him to repeat this work with

special care and the results for solid cyanin films given in his last<sup>1</sup> paper are shown in Table VI.

TABLE VI.

$\lambda$	635	620	589	570	565	535	520	505	485	440	400
$\mu$	0.53	0.67	0.69	0.75	0.74	0.46	0.28	0.15	0.06	0.00	0.00

Pfüger made an elaborate comparison of these data with the values calculated by the Ketteler-Helmholtz dispersion formula.

To overcome the difficulties of making prisms by Pfüger's method and in hopes of securing better results R. W. Wood<sup>2</sup> dissolved the dye in Canada balsam and poured the solution while hot into the V shaped opening between two glass plates. Although the prisms thus made were superior to those obtained by Pfüger, the dye was still in solution and the same objection could be made as for dyes in alcoholic solution. He next tried to fuse several of the aniline dyes and found that with cyanin this was a singular success. While in a fluid state the cyanin was pressed into an acute prism between two pieces of plate glass. After cooling, one of the plates was removed by a sharp blow, the prism remaining fixed on the other. The advantages of this method are several:

- 1st. The rapidity and comparative ease of making good prisms.
- 2nd. The increased accuracy of the measurement of the refracting angle which the superiority of the optical surface makes possible.
- 3rd. The improved definition of the transmitted beam on account of the uniformity of the prism.
- 4th. The ability to obtain prisms of almost any desired angle. Pfüger considers an angle of  $2' 6''$  remarkably large while by this method prisms have been made with a refracting angle of  $2^\circ$  and over and no special difficulty would be met if larger angles were desired.

<sup>1</sup> Pfüger, Wied. Ann. LXV., p. 227.

<sup>2</sup> Wood, Phil. Mag. XLVI., p. 389, (1898).

(b) *Theoretical*.—The great importance of the phenomenon of anomalous dispersion in the theory of light is, perhaps, best seen when the various theories framed for the explanation of dispersion are examined. Kundt's discovery of the evident dependence of dispersion upon absorption rendered necessary a thorough revision of the older theories regarding this phenomenon.

The fundamental assumption of the wave theory of light is the existence of a medium, called the ether, which pervades all space and in which luminiferous vibrations are propagated as if in an elastic solid. Upon this basis the velocity of transmission of a light wave is given by the expression,

$$V = C \sqrt{\frac{E}{D}} \quad (3)$$

where  $E$  is the elasticity of the medium;  $D$ , its density;  $V$ , wave velocity; and  $C$ , a constant.

To account for the difference in the velocity of the transmission of light in transparent media and in free space by this equation, three suppositions may be made.

$$(a). \ E \text{ may be constant and } D \text{ variable, } \therefore V = \frac{C_1}{\sqrt{D}} \quad (4)$$

$$(b). \ E \text{ may be variable and } D \text{ constant, } \therefore V = C_2 \sqrt{E} \quad (5)$$

$$(c). \ \text{Both } E \text{ and } D \text{ may vary, } \therefore V = C \sqrt{\frac{E}{D}} \quad (6)$$

The first assumption was made by Fresnel<sup>1</sup> while the theories of Neumann<sup>2</sup> and McCullagh<sup>3</sup> depend upon the second. Both assumptions lead to identical results, except, that the plane of vibration must be considered perpendicular to the plane of incidence in the first case and parallel to it in the second. The third case, if treated by methods similar to those employed by Fresnel, Neumann, or McCullagh, leads to results not agreeing with known facts. These theories would be sufficient to explain

<sup>1</sup> Fresnel, *Ann. de Chim. et de Phys.* XLVI., p. 225. *Oeuvres complètes*, I., p. 767.

<sup>2</sup> Neumann, "Vorlesungen über Theoretische Optik," edited by Dr. E. Dorn, Leipzig, 1885.

<sup>3</sup> McCullagh, *Trans. Roy. Soc. Irish Acad.* Vol. XXI.

refraction if all colors were deviated the same amount, but for dispersion, or the difference in the velocity of transmission of light of various wave lengths they offer no solution.

To explain the fact that in material media light waves, differing in wave length, are propagated with different velocities, while in free space all light waves are transmitted with the same velocity, Cauchy<sup>1</sup> made the following assumptions:

- 1st. That the ether is of a granular structure.
- 2nd. That there is a certain attractive force between ether and matter so that inside a material body the ether is very much denser than in free space.
- 3rd. That the distance between the ether particles inside the body is comparable to the wave length of light, while in free space it is of a different order.
- 4th. That the period of vibration of a wave is constant, and hence, that the wave length varies with the velocity of transmission.

From these assumptions Cauchy developed the following expression for the velocity of transmission of light in terms of the wave length in the medium:

$$V^2 = A_1 + A_2 \left(\frac{2\pi}{\lambda}\right)^2 + A_3 \left(\frac{2\pi}{\lambda}\right)^4 + \text{\&ct.} \quad (7).$$

where  $A_1$ ,  $A_2$ ,  $A_3$ , etc., are constants depending upon the nature of the medium. While calculating the values of these constants he observed that this series is rapidly converging and that for all practical purposes it may be sufficient to use the first two terms, thus:

$$V^2 = A_1 + A_2 \left(\frac{2\pi}{\lambda}\right)^2 \quad (8).$$

From his 4th assumption there results:  $\lambda : \lambda' :: v : v'$  where  $\lambda$  is the wave length in free space and  $v$  the velocity. Combining this with equation (8), making a series of transformations, and

---

<sup>1</sup> Cauchy, *Memoire sur la dispersion de la lumière*. Prag. 1836. Beer:—*Einleitung in der höheren Optik*, p. 209, Braunschweig, 1853.



dropping terms of higher order, he derived the following equation for the index of refraction:

$$\frac{1}{\mu^2} = A_1 + \frac{A_2}{\lambda^2} + \frac{A_3}{\lambda^4} + \&ct. \quad (9).$$

Christoffel<sup>1</sup> showed that when Cauchy made his transformations to derive (9) from (8) he assumed  $A_2$  to be small in comparison with  $A_1$  and, hence, practically used only one constant. Christoffel devised a new method of solving equation (8) that did not require the second assumption, and showed that the index of refraction can be represented by equation (10):

$$\mu = \frac{n_0 \sqrt{v}}{\sqrt{1 + \frac{\lambda_0}{\lambda}} + \sqrt{1 - \frac{\lambda_0}{\lambda}}} \quad (10).$$

The problem of dispersion was also studied by Redtenbecker<sup>2</sup> and upon the supposition that each molecule is surrounded by a dense ether shell he obtained the formula:

$$\frac{1}{\mu^2} = A + \frac{B}{\lambda^2} + C\lambda^2 \quad (11).$$

The subject was next treated by Briot.<sup>3</sup> He considered the assumptions made by Cauchy insufficient to explain dispersion, inasmuch as a change in density alone could not give a different *order* to the distances between the ether particles, and consequently, if the wave length were a function of the velocity inside a material body the same must be true in free space. To remedy this defect he assumed a direct action of the material particles upon the velocity of the transmission of light and expressed this by adding a term  $K\lambda^2$  to Cauchy's formula, thus:

$$\frac{1}{\mu^2} = K\lambda^2 + A_1 + \frac{A_2}{\lambda^2} + \frac{A_3}{\lambda^4} + \&ct. \quad (12).$$

This formula he tested by the best experimental data obtainable and found that the term  $K\lambda^2$  was small and in most cases could

<sup>1</sup> Christoffel, Pogg. Ann. CXVII., p. 27, (1861).

<sup>2</sup> Redtenbecker, Dynamiden-System. Mannheim, (1857).

<sup>3</sup> Briot, "Essai sur la théorie mathématique de la lumière." Paris, 1863; Leipzig, 1867; C. R. LVII., p. 866.

be neglected. Ketteler<sup>1</sup> in 1870 determined the value of the constants, in Briot's formula, for several substances and found that the calculated values for the index of refraction agreed closely with those observed.

It was at this time that Christiansen and Kundt brought the phenomenon of anomalous dispersion into prominence. These remarkable observations could not be explained by either Cauchy's or Briot's equations, but rendered necessary the construction of a new theory.

Sellmeier<sup>2</sup> made the first attempt and laid the basis for further work. His assumptions are as follows:

- 1st. The existence of an ether of constant elasticity and density.
- 2nd. The retardation of the light is entirely due to the interaction between the ether and the material particles.
- 3rd. The intensity of the interaction depends upon the ratio between the natural period of vibration of the material particles and of the wave length, and that an absorption line results when this ratio is unity.
- 4th. That each material particle is entirely free to vibrate without affecting the other particles.

Several minor assumptions are made in the development of the first equation to simplify the calculations or even to make them possible.

From these assumptions Sellmeier deduces the following formula for the refractive index:

$$\mu^2 - 1 = \sum \frac{m t^2 a_0^2}{m' a^2} \quad (13).$$

Where  $t$  equals period of vibration of  $\lambda$ .

Where  $d$  equals natural period of vibration of material particle.

Where  $a_0$  equals amplitude of center of gravity of material particle.

Where  $a$  equals amplitude of ether vibration.

Where  $m'$  equals mass of ether in unit volume.

Where  $m$  equals mass of matter in unit volume.

<sup>1</sup> Ketteler, Pogg. Ann. CXL., p. 1.

<sup>2</sup> Sellmeier, Pogg. Ann. CXLV., pp. 399, 520; CXLVII., pp. 387, 535, (1878).

It is noteworthy that Lord Kelvin<sup>1</sup> in a paper read before the Royal Society of Edinburgh, February 6th, 1899, on the absorption line of sodium vapors, used Sellmeier's formula.

Kelvin's<sup>2</sup> theory is quite similar to that of Sellmeier, the chief peculiarity being the conception of concentric spherical shells, connected by zigzag springs, to represent a molecule having more than one natural period of vibration.

Under the assumption of a diatomic molecule of this form he writes the equation thus:

$$\left(\frac{V_2}{V_1}\right)^2 = 1 + \frac{m T^2}{T^2 - K^2} + \frac{m_1 T^2}{T^2 - K_1^2} \quad (14).$$

Where T equals period of vibration of ether light wave.

Where K equals natural period of vibration of one shell.

Where K<sub>1</sub> equals natural period of vibration of the other shell.

Where m equals density of 1st shell, using ether as unity.

Where m<sub>1</sub> equals density of 2nd shell, using ether as unity.

This theory of mutual reaction between matter and ether was next developed by Helmholtz.<sup>3</sup> Let u, v, w, be the displacements of the ether particles of density m, in an element of volume dv; U, V, W, the displacements of the material particles of density m'; then, considering the forces along X axis only, he forms two equations of motion, thus:

$$m \frac{d^2 u}{dt^2} = X + X' + A + \&ct. \quad (15a).$$

$$m \frac{d^2 U}{dt^2} = X_1 + X'_1 + A_1 + \&ct. \quad (15b).$$

Where X equals action of ether particles external to dv;

Where X' equals external impressed force on m.

Where A equals direct action of the material particle in dv on the ether;

Where X<sub>1</sub> equals action of matter external to element dv.

Where X'<sub>1</sub> equals external impressed force on m.

Where A<sub>1</sub> equals direct action of the ether in dv on the material particles.

<sup>1</sup> Kelvin, Phil. Mag. XLVII., p. 302.

<sup>2</sup> Kelvin, Baltimore Lectures, 1884.

<sup>3</sup> Helmholtz, Pogg. Ann. CLIV., p. 552.

To derive expressions for these forces, Helmholtz made the following assumptions:

1st. The impressed forces are supposed to vanish; hence:

$$X_1 = X_1' = 0.$$

2nd. The medium is supposed to be perfectly elastic; hence:

$$X = a^2 \frac{d^2 u}{dz^2} \quad (17a).$$

$$X_1 = -a^2 U - \gamma^2 \frac{dU}{dt} \quad (17b).$$

3rd. The force of restitution in an elastic medium is proportional to the displacement; hence:

$$A = \beta^2 (U - u) \quad (18).$$

4th. The action is supposed to be confined to the element of volume  $dv$ ; hence:

$$A + A_1 = 0 \quad (19).$$

Substituting the values thus found for  $X$ ,  $X_1$ ,  $X'$ ,  $X'_1$ ,  $A$  and  $A_1$  in (15a) and (15b) we have:

$$m \frac{d^2 u}{dt^2} = a^2 \frac{d^2 u}{dz^2} + \beta^2 (U - u) \quad (20a).$$

$$m' \frac{d^2 U}{dt^2} = -\beta^2 (U - u) - a^2 U - \gamma^2 \frac{dU}{dt} \quad (20b).$$

These are the fundamental differential equations in Helmholtz's dispersion theory. Solving, he finds:

$$\mu_0^2 - X^2 - 1 = \frac{B \lambda^2}{m h^2 m'} + \frac{\frac{B}{m m'} \frac{\lambda^4}{\lambda_m^4} \left[ \left(1 - \frac{B}{m'}\right) \frac{\lambda^2}{\lambda_m^2} - 1 \right]}{\left[ \left(1 - \frac{B}{m'}\right) \frac{\lambda^2}{\lambda_m^2} - 1 \right]^2 + G^2 \frac{\lambda^2}{\lambda_m^2}} \quad (21a).$$

$$2 \mu_0 X_0 = \frac{\frac{B^2}{m m'} G \frac{\lambda^2}{\lambda_m^2}}{\left[ \left(1 - \frac{B}{m'}\right) \frac{\lambda^2}{\lambda_m^2} - 1 \right]^2 + G^2 \frac{\lambda^2}{\lambda_m^2}} \quad (21b).$$

Where  $\mu_0$  equals the refractive index at perpendicular incidence;  $x_0$ , the extinction coefficient, for  $\lambda$  at perpendicular incidence; and  $\lambda_m$ , wave length of absorption band.

Lommel<sup>1</sup> makes the same arguments as Helmholtz except for the force  $A$ , but considers the "action to follow Newton's law of friction," and, hence, his fundamental equations become:

$$m \frac{d^2 u}{dt^2} = a^2 \frac{d^2 u}{dz^2} \mp \beta^2 \frac{d}{dt} (U - u) \quad (22a).$$

$$m' \frac{d^2 U}{dt^2} = \pm \beta'^2 \frac{d}{dt} (U - u) - a'^2 U - \gamma'^2 \frac{dU}{dt} \quad (22b).$$

Lommel gave the first set of signs but Ketteler<sup>2</sup> and Voigt<sup>3</sup> argued that the lower set should be used. Lommel<sup>4</sup> replied, still defending his first position, but, in the opinion of Glazebrook,<sup>5</sup> without success.

Solving equations (22) and (23)

$$\mu^2 \cdot -X^2 \cdot -1 = \frac{\frac{B'^2}{m m'} \frac{\lambda^2}{\lambda_m^2} \left( \frac{\lambda^2}{\lambda_m^2} - 1 \right)}{\left( \frac{\lambda^2}{\lambda_m^2} - 1 \right)^2 + \left( \frac{B'}{m'} - G \right)^2 \frac{\lambda^2}{\lambda_m^2}} \quad (23a).$$

$$2 \mu \cdot X \cdot = \frac{\frac{B' \lambda^2}{m \lambda_m^2} + \frac{\frac{B'^2}{m m'} \left( \frac{B^2}{m'} - G \right) \frac{\lambda^2}{\lambda_m^2}}{\left( \frac{\lambda^2}{\lambda_m^2} - 1 \right)^2 + \left( \frac{B'}{m'} - G \right)^2 \frac{\lambda^2}{\lambda_m^2}} \quad (23b).$$

Ketteler<sup>6</sup> makes a third suggestion. He supposes the action between ether and matter to be proportional to the acceleration instead of the velocity as suggested by Lommel, therefore, expressing the force  $A$  thus:

$$A = \frac{\delta^2}{\delta t^2} (U - u) \quad (24).$$

The resulting equations when solved can be reduced to those of Helmholtz by making  $B\lambda^2 = B'$ . Ketteler<sup>7</sup> has written a large

<sup>1</sup> Lommel, Wied. Ann. III., p. 330.

<sup>2</sup> Ketteler, *ibid.* XVIII., p. 387.

<sup>3</sup> Voigt, *ibid.* XVII., p. 468.

<sup>4</sup> Lommel, *ibid.* XIX., p. 908.

<sup>5</sup> Glazebrook, B. A. A. S. Report, 1885, p. 222.

<sup>6</sup> Ketteler, *Theoretische Optik*, p. 78.

<sup>7</sup> Ketteler, Wied. Ann. XVI., p. 86; XII., p. 363; XV., p. 613; XVIII., pp. 337, 631; XXI., pp. 199, 178; XLIX., pp. 382, 509; LIII., p. 823.

number of papers, in which dispersion is discussed from several points of view. To briefly state his views would be impossible, still, the main idea in his works on dispersion seems to be this: the mutual reactions between ether and matter, that is, the  $A'$  and  $A$  forces, are unknown, and, hence, they should be eliminated from equations. The total work done per unit of time on the whole system is equated to the rate of change of kinetic energy, and in this the mutual reactions do not appear.<sup>1</sup> Thus, he obtains the following equation:

$$m \frac{d^2 u}{dt^2} du + m' \frac{d^2 U}{dt^2} dU = e \nabla^2 u du - K U dU. \quad (25).$$

Where  $u$ ,  $U$  are displacements and  $e$  the rigidity of ether in free space. The notation is changed so as to make it uniform throughout this paper. Those equations he combines with a "second equation relating to the special mode of action of the matter particles which can be no other than the renowned fundamental equation of Bessel's theory of the pendulum." This<sup>2</sup> he writes:

$$m \frac{d^2 u}{dt^2} C + m' \frac{d^2 U}{dt^2} = -K U. \quad (26).$$

These equations would apply for transparent media, and when absorption takes place terms are added for the reaction of the matter on the ether. The fundamental equations then become<sup>3</sup>

$$m \frac{d^2 u}{dt^2} - m' \frac{d^2 U}{dt^2} C = e \frac{d^2 u}{dz^2} + b m' U + c m' \frac{dU}{dt} \quad (27a).$$

$$\frac{d^2 u}{dt^2} C + \frac{d^2 u}{dt^2} = -K' U - g' \frac{dU}{dt} \quad (27b).$$

<sup>1</sup> Ketteler, Wied. Ann., XXI, p. 201.

<sup>2</sup> Ketteler, *ibid.* XXI, p. 201; XVIII, p. 413.

<sup>3</sup> Ketteler, "Theoretische Optik," pp. 93-95.

Solving these, Ketteler finds:<sup>1</sup>

$$\mu_0^2 - X_0^2 - 1 = C \frac{m'}{m} \frac{\left( B \frac{\lambda^2}{\lambda_m^2} - C \right) G \frac{\lambda}{\lambda_m} - H' \frac{\lambda}{\lambda_m} \left( \frac{\lambda^2}{\lambda_m^2} - 1 \right)}{\left( \frac{\lambda^2}{\lambda_m^2} - 1 \right)^2 + G \frac{\lambda^2}{\lambda_m^2}} \quad (23a).$$

$$2\mu_0 X_0 = C \frac{m'}{m} \frac{\left( B \frac{\lambda^2}{\lambda_m^2} - C \right) G \frac{\lambda}{\lambda_m} - H' \frac{\lambda}{\lambda_m} \left( \frac{\lambda^2}{\lambda_m^2} - 1 \right)}{\left( \frac{\lambda^2}{\lambda_m^2} - 1 \right)^2 + G^2 \frac{\lambda^2}{\lambda_m^2}} \quad (23b).$$

A new phase was given to the subject in 1893 when Helmholtz<sup>2</sup> produced his theory of dispersion based upon the electromagnetic theory of light. He postulates charged bodies imbedded in an ether transmitting electric disturbances, and that the forces acting upon the ether during these disturbances can set the material particles in vibration. He follows the electrolytic theory in assuming that electric charges of definite magnitude are accumulated at the center of affinity of chemically combined ions, that these charges may be either positive or negative but always have the same absolute value for every center of affinity. "If the ether surrounding a pair of combined ions is traversed by electric forces and thereby dielectrically polarized, the oppositely charged ions will be subjected to stresses in the direction of the lines of force, that is, to two forces of equal magnitude but opposite in direction which together form a couple; this couple will not set the center of mass of the molecule in motion, but it will tend to lengthen or shorten the electrical axis of the molecule and to deflect it towards or away from the direction of the lines of force." The pairs of ions as used by Helmholtz possess mass and inertia in addition to the usual properties of dielectrically polarized molecules of insulating substances. Hence, oscillations may throw them out of equilibrium and produce variations in the electrical moments due to these ionic charges, *f*, *g*, *h*, forces, independently of the electrical moments per unit volume, *f*, *g*, *h*, forces, of the free ether.

<sup>1</sup> Ketteler, "Theoretische Optik," p. 100.

<sup>2</sup> Helmholtz, Wied. Ann. XLVIII., pp. 339, 723; L. E. XXXVII., p. 404.

In the energy equation Helmholtz takes account of electrostatic, magnetic, electro-magnetic, and mechanical forces and derives equations representing each. Finally, he applies the Principle of Least Action considering variations to be present in  $f$ ,  $g$ ,  $h$ ,  $f$ ,  $g$ ,  $h$ , and  $\mathfrak{F}$ ,  $\mathfrak{G}$ ,  $\mathfrak{H}$ , and derives an expression for the refractive index.

Heaviside<sup>1</sup> criticizes several points, especially the term electro-magnetic energy, and the application of the Principle of Least Action.

Ketteler<sup>2</sup> has shown that the dispersion formula developed by Helmholtz, from the electro-magnetic theory, and the one published by himself, based on the elastic solid theory, can be expressed by the same equation.

$$\mu_0^2 - X_0^2 - 1 = \Sigma \frac{D \lambda^2 (\lambda^2 - \lambda_m^2)}{(\lambda^2 - \lambda_m^2)^2 + g^2 \lambda^2} \quad (29a).$$

$$2\mu_0 X_0 = \Sigma \frac{D g \lambda^2}{(\lambda^2 - \lambda_m^2)^2 + g^2 \lambda^2} \quad (29b).$$

Where  $\mu_0$  equals refractive index for wave length  $\lambda$  at perpendicular incidence.

Where  $X_0$  equals extinction index for wave length at perpendicular incidence.

Where  $\lambda_m$  equals wave length in free ether of rays absorbed.

Where  $D$  equals a constant depending, in the elastic theory, upon the refractive index of infinitely long waves, and, in the electro-magnetic theory, upon the dielectric constant of the medium. These equations are usually termed the Ketteler-Helmholtz dispersion formula, and were tested by Pfüger<sup>3</sup> as described in the first part of this paper.

<sup>1</sup> Heaviside, L. E. Vol. XXXVII., p. 470.

<sup>2</sup> Ketteler, Wied. Ann. XLIX., p. 382; LIIL, p. 823.

<sup>3</sup> Pfüger, Ibid., LXV., pp. 173, 225.



## PART II.

## EXPERIMENTAL WORK.

The superiority of the optical surface of cyanin prisms, made by pressing together the fused crystals between glass plates, and the larger angles available lead one to suppose that more accurate determinations of the dispersion can be made with such prisms than with those obtained by the evaporation of alcoholic solutions of the dye. Of special theoretical interest are the values of the refractive indices for wave lengths within the absorption band. The results of the experiments give conclusive evidence of the continuity of the dispersion curve through the absorption band in the yellow and show the presence of a second absorption band in the ultra violet, beginning at wave length,  $368 \mu\mu$ , which has not been heretofore observed and which should be taken into account in proving the Ketteler-Helmholtz dispersion formula.

The first part of the experimental work consisted of a systematic examination of all the available aniline dyes known to show anomalous dispersion with a view to determining:

1st. How many of them could be formed into prisms by the fusion method.

2nd. The precautions necessary for the formation of prisms of the best quality.

From Fuchsin, Aniline Green, Hoffmann's Violet, Uranin, and Aurine, prisms were made, but with difficulty. Their quality was, however, too poor to warrant any further work. The Uranin absorbs moisture from the atmosphere and dissolves if not protected. Acid Magenta, Erithrosene, Aniline Red, Rose Bengale, Genetian Violet, and Methyl Blue could not be made into prisms by this method. Cyanin fuses at about  $116^{\circ}\text{C}$ , becoming a pasty substance for a few degrees and then a liquid of

a deep plum color and of the consistency of a rather thick syrup. The crystals when heated to about  $80^{\circ}$  C change color from a bright green to a golden brown. After fusing the cyanin rapidly evaporates and leaves a solid residue.

To secure good prisms the heating of the cyanin must be done rapidly, the prism formed, pressed, and cooled quickly and at the right temperature. If too cool, the fused mass can not be pressed into the required thinness; and if too hot, a number of small pin holes will appear, due to the gas bubbles formed. The pressure applied is also a factor that must be carefully adjusted if good results are to follow. This becomes very important when thin prisms are desired. For work in the transparent parts of the spectrum, prisms of  $10'$  to  $20'$  angle can be used, but in and near the absorption band they must be exceedingly thin to let any light through.

Cyanin being found to be the only dye from which wholly satisfactory prisms could be formed it was decided to limit the work to an examination of the dispersion of this single substance.

Four distinct methods have been employed, namely:

(a) Direct spectrometer readings in the visible spectrum, the slit of the instrument being illuminated with monochromatic light.

(b) Photographic records of the deviation of a system of monochromatic rays from a Rowland concave grating illuminated by an iron arc.

(c) A qualitative method based on Newton's principle of crossed prisms.

(d) Photographic records of the displacement of the fringes in the Michelson interferometer produced by thin films of cyanin.

(a) *The visible part of the spectrum.* The first method was employed by Wood:<sup>1</sup> A plan of the apparatus is shown in figure 3. Sunlight reflected from a heliostat (A) is concen-

---

\* Phil. Mag. XLVI (1898), p. 380.

trated upon the slit of a large, direct vision spectroscope (C), the eye-piece of the latter being removed, and in its place is fixed the slit of a Geneva Society Spectrometer (D), the eye-

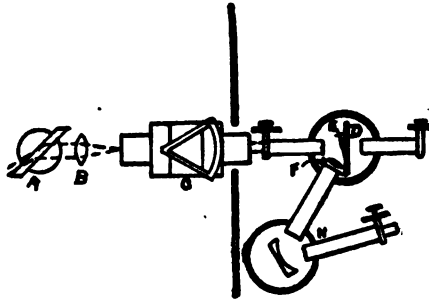

FIG. 3.

piece of which is provided with a filar micrometer. The glass plate on which the cyanin prism (E) had been formed was covered with black paper, in which two small apertures had been cut, one coming over the cyanin prism and the other slightly to one side of it. The latter, or clear aperture, gave a direct image of the slit of the spectrometer; the former, a deviated image, due to the bending of the rays by the prism. Both images being in the field of the telescope at once, the distance between them could be measured by the filar micrometer, and these readings when reduced to the circular scale, furnished the data from which the refractive indices were calculated. Any slight deviation due to the possible prismatic form of the glass plate used was thus eliminated. By turning a tangent screw, operating on the prism system of the direct vision spectroscope, the focused spectrum could be made to traverse the slit of the spectrometer, which was thereby illuminated with monochromatic light of any desired wave length.

To determine the wave length of the light corresponding to any particular reading of the cyanin prism the following methods were used. First, by opening the slit rather wide a considerable portion of the solar spectrum was allowed to enter the instrument in which the Fraunhofer lines were distinctly visi-

ble. Some line of known wave length was chosen and by narrowing the slit the spectrum was gradually cut down until only light in the immediate vicinity of the line remained. In those parts of the spectrum where no conspicuous and easily recognized line existed a different method was employed. Removing the prism and placing a small mirror in its place, the light was thrown on a Brashear reflection grating spectrometer (See H, Fig. 3). This instrument had previously been graduated and the readings for the principal Fraunhofer lines been taken in its fixed position, and, hence, the wave length of any light used could be determined.

The angles of the cyanin prisms were measured by the Geneva Society Spectrometer. The prism was placed with its refracting edge vertical and at the center of the circular table. Parallel rays ( $a b$ , Fig. 4) coming from the collimator are reflected from the glass plate in the direction  $b d$  and from the surface of

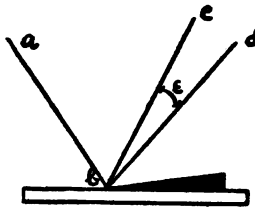

FIG. 4.

the prism along  $b c$ . The angle  $e$  between the reflected rays is twice the angle of the prism. For prisms of small angle both images of the slit were in the field of the telescope and the distance between them was measured by a filar micrometer. These readings were then reduced to the circular scale. For larger angles the readings were taken on the circular scale direct.

If  $A$  represents the angle of the prism and  $d$  the deviation, both in circular measure, the index of refraction is found by the usual formula:

$$\mu = \frac{\sin \frac{1}{2} (A + d)}{\sin \frac{1}{2} A} \quad (30).$$

The angles of the prisms being very small, we can replace the sides of the angles by their circular measures, thus:—

$$\mu = 1 + \frac{d}{A} \quad (31).$$

By this formula the indices given in Table VII were calculated.

Plate 16 shows graphically the contents of Table VII. The abscissæ are wave lengths in  $\mu \mu$  units, while the ordinates are indices of refraction.

For three reasons the results are not so good in the absorption band as in the red and blue parts of the spectrum. These are:

1st. To transmit the yellow light the prisms must be very thin, and hence, of small angle. This increases the percentage error in measuring the angle of the prism as well as the deviation.

2d. The image of the slit made by the deviated ray was not as sharply defined in the absorption band as in the transparent parts, a diffraction haze appearing around the image due to the narrow portion of the prism through which the light could pass.

3d. Any slight error in measuring the wave lengths would affect the result to a larger degree in this portion of the curve than in the other parts.

TABLE VII.  
Prism No. 1. Angle 17' 3".8.

$\lambda$	$\mu$	$\lambda$	$\mu$	$\lambda$	$\mu$	$\lambda$	$\mu$
765.0	1.920	479.8	1.387	463.7	1.434	434.2	1.524
759.0	1.970	479.2	1.387	461.0	1.449	429.5	1.535
735.0	1.965	475.6	1.416	456.8	1.460	427.0	1.533
703.5	2.050	475.3	1.401	451.8	1.479	419.1	1.544
682.7	2.131	472.7	1.408	444.2	1.496	410.8	1.537
685.6	2.150	470.0	1.418	438.0	1.523	406.5	1.553
486.7	1.390						

Prism No. 2. Angle 4' 52".8.

$\lambda$	$\mu$	$\gamma$	$\mu$	$\gamma$	$\mu$
668.0	2.23	518.3	1.15	501.8	1.27
658.1	2.34	514.2	1.15	495.8	1.23
524.8	1.12	504.8	1.19	489.6	1.35

Prism No. 3. Angle 23' 59".7.

Prism No. 4. Angle 1' 17".2.

$\lambda$	$\mu$	$\lambda$	$\mu$
732.0	2.027	663.6	2.31
688.0	2.170		

Prism No. 5. Angle 24".7.

$\lambda$	$\mu$	$\lambda$	$\mu$	$\lambda$	$\mu$	$\lambda$	$\mu$
667.5	2.26	610.0	2.14	589.0	1.65	564.0	1.30
646.5	2.35	607.0	2.06	589.0	1.59	550.5	1.22
633.5	2.30	607.0	1.93	580.0	1.57	540.0	1.12
633.0	2.35	599.5	1.86	580.0	1.59	518.2	1.14
623.5	2.33	597.0	1.79	568.0	1.45	506.5	1.22
610.0	2.10						

TABLE VII — Continued.

Prism No. 11. Angle 32'.7.

$\lambda$	$\mu$	$\lambda$	$\mu$	$\lambda$	$\mu$	$\lambda$	$\mu$
606.2	1.88	518.0	1.12	561.0	1.27	581.0	1.13
599.2	1.81	486.5	1.33	589.5	1.58	518.3	1.13
Prism No. 13. Angle 51'.7.				Prism No. 14. Angle 21' 5".8.			
$\lambda$	$\mu$			$\lambda$	$\mu$		
622.8	2.25			723.6	2.014		
589.5	1.67			723.6	2.020		
				423.0	1.507		

Prism No. 15. Angle 2' 10".1.

$\lambda$	$\mu$	$\lambda$	$\mu$	$\lambda$	$\mu$
738.0	2.01	655.5	2.32	469.0	1.40
688.0	2.19	502.0	1.24	451.0	1.51
672.0	2.25	486.5	1.37	441.0	1.50
657.0	2.32				

(b) *Investigations in the Ultra Violet.*—The dispersion having been measured visually with the spectrometer as far into the violet region as was possible, the photographic method employed by Pfüger<sup>1</sup> was adopted to extend the work into the ultra violet. The arrangement of the apparatus is seen in figure 5 except that sunlight was used instead of the light from the iron arc.

A solar spectrum thrown by a Rowland concave grating was received upon a photographic plate. Between the grating, E, Fig. 5, and the plate, F, was placed an opaque screen, H, provided with a rectangular aperture over which was fastened the glass plate supporting the cyanin prism. A strip of black pa-

<sup>1</sup> Pfüger, Wied. Ann. LXV., p. 206.

per, furnished with two small apertures, was mounted over the plate, one aperture exposing the prism, the other, clear glass. Thus, the light arrived at the sensitive plate by two paths, one direct and the other deviated by passing through the cyanin prism. Therefore, two sets of the Fraunhofer lines were found

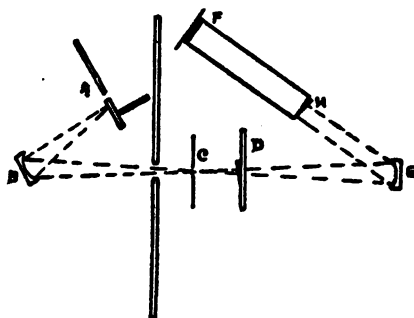

FIG. 5.

on the plate, of which two sample photographs are seen in plate 19, figures 1 and 2. The upper set of lines was formed by rays coming through the prism and the lower set by the direct path. For making these photographs the angle of the prism was  $2' 51.5''$ , the distance from the prism to the plate was 177.6 c. m., while the time of exposure for the direct ray was three minutes and for the other seven minutes.

The distance between a given line in one set and the corresponding line in the other set was measured by a filar micrometer attached to the eye-piece of a microscope. Let  $X$  be this distance in centimeters; let  $d$  be the distance from the plate to the prism in centimeters, and let  $\alpha$  be the angle of the prism in seconds of arc, then the index of refraction for the wave length used is given by the following formula:—

$$\mu = 1 + \frac{X \overline{360}^2}{2 \pi d \alpha} \quad (32).$$



By this method the indices given in Table VIII, were calculated.

TABLE VIII.

$\lambda$	$\mu$	$\lambda$	$\mu$
422.7	1.530	.....	.....
410.0	1.563	380.0	1.60
404.0	1.573	372.0	1.61
396.0	1.606	.....	.....

These values of  $\mu$  are indicated on Plate 16 by crosses and the values obtained with the spectrometer by circles.

To continue the work in the fall and winter, when cloudy weather made sunlight unavailable, an electric arc formed between an iron rod and a rapidly rotating iron disk, was substituted for the sunlight. The bright lines in the iron spectrum gave the same results as the Fraunhofer lines. With light of wave length shorter than  $368 \mu \mu$ , passing through the cyanin prism, no effect could be produced on the sensitive plate although a five hours continuous exposure was made. To increase the intensity of light when passing through the cyanin, the prism was moved from H to D, eight centimeters behind the slit, C (Fig. 5).

With this arrangement of the apparatus photographs were taken and the results are shown in figures 3, 4, 5, and 6 of plate 19. Light coming by the direct path made the upper set of lines, while the part coming through the cyanin formed the lower set. In figure 3 the time of exposure for the upper set was forty seconds, and for the lower, seventy seconds. For the longer waves the intensity of the two sets of lines in this photograph is almost the same, but beyond  $368 \mu \mu$  no lines appear in the lower set. The cyanin evidently absorbed the energy of wave lengths shorter than  $368 \mu \mu$ . The presence of this absorption band in the cyanin and the approach to the absorption band in the glass beginning at  $335 \mu \mu$  is seen in figure 4 of plate 19. The time of exposure in the photograph of the latter, by the direct ray, was forty seconds, and through the cyanin five minutes.

To show the similarity between this effect and the action due to the absorption in the green, figures 5 and 6 of plate 19 were taken. In the former the time of exposure for the direct ray was forty-five seconds and for the cyanin five minutes. This gives approximately the same intensity for the lines of shorter wave length in the photograph, but for the longer wave no impression is seen in the lower band. Figure 6 is the same as figure 5 save the time of exposure, which in this case was forty seconds for both sets. By comparing the wave lengths with the absorption curve it is seen that the photographs of figures 5 and 6 are at the edge of the absorption band in the yellow.

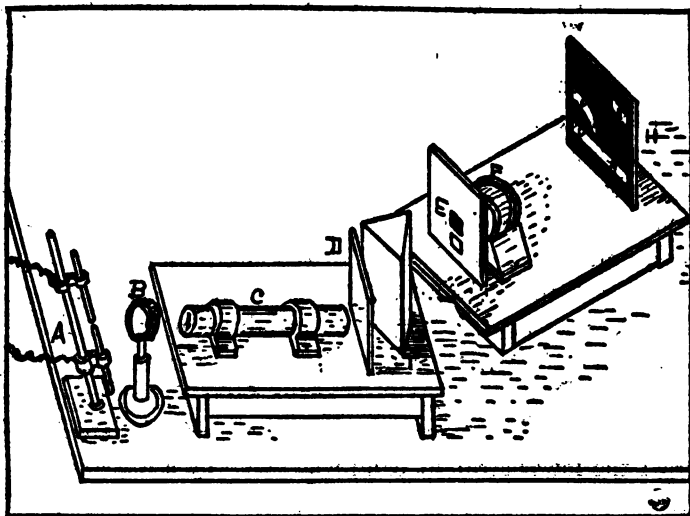

FIG. 6.

(c) *The Method of Crossed Prisms.*—In Newton's method of crossed prisms we have a beautiful means of showing the phenomenon of anomalous dispersion, for by it we can bend a straight, continuous spectrum into a curve identical in every respect with the dispersion curve obtained by measurements with the spectrometer. The method was used by Kundt in the course of his investigations on anomalous dispersion. This method furnishes qualitative data only, but the fact that the curve of dispersion is directly photographed gives value to the results. The general arrangement of the apparatus is seen in figure 6.

The light of an arc lamp, A, was focused on the slit of the spectrometer, C, and parallel rays coming from the collimator passed through a water prism, T, and falling on an achromatic lens, F, of long focus (a telescope lens of six feet focus) formed a sharply defined spectrum, V—R, on the photographic plate, H. In front of the objective, F, was placed a cyanin prism, E, with its refracting edge *horizontal* and turned down. This prism deviated all the rays *upwards* before they entered the lens, F, thus elevating the image on the photograph. Since the deviation is due to the fact that light is transmitted slower in cyanin than in air, and that the velocity of transmission is a function of the wave length, therefore, the elevation of light of any wave length will be proportional to  $\mu - 1$  where  $\mu$  is the index of refraction for the given wave length. Consequently, if the spectrum produced by the water prism is considered to be normal then the crossed prism spectra produced by the cyanin prism as described above, is a curve identical in every respect with the curve of dispersion calculated by the direct spectrometer method and shown graphically in the curve of plate 16. Erythro plates were used and the more intense action of the blue and violet was modified by the introduction of an Aurantia color screen or filter, D. In this way fully exposed photographs were obtained of the dispersion curve from the extreme red to the violet. The results are seen in figures 1-6 of plate 20. For figure 1 the lower straight band was made by a direct exposure, while the curved strips above are parts of the same spectrum after having passed through the cyanin prism. The angle of the prism was  $17' 1.0''$ , and the time of exposure, by the direct path, was twenty seconds, while through the cyanin it was one hour. The yellow part of the spectrum is absent, the prism absorbing all the energy of this wave length. For figures 2 and 3, the same method of procedure was pursued, and these photographs are inserted to show the effect of the Aurantia color screen, D. The angle of the cyanin prism used for these photographs was  $17' 3.8''$ . For figure 3 no screen was employed; for figure 1 the light was passed through a screen of medium thickness, while for figure 2 a rather dense filter was used. The haze

appearing in figure 3, where no color screen was used, is entirely absent in figures 1 and 2, while the form of the curve is apparent in all. Cyanin has a very strong absorption band in the yellow, and to let any light through in this part of the spectrum very thin prisms must be used. In figure 4 of the same plate is seen a photograph of a crossed prism spectrum when the cyanin prism was thin enough to let light of all wave lengths pass through. The refracting angle was only  $24.7''$ , so the deviation is small, but the continuity of the curve is evident. No exposure was made by the direct path to avoid overlapping of the two spectra. A photograph of a similar continuous crossed prism spectrum for a cyanin prism of  $2' 51.6''$  refracting angle, is seen in figure 5 of the same plate, in which the deviations are proportionally larger than in figure 4, and the form of the curve can easily be followed through the absorption band. In figure 6 the results are seen of four successive exposures through a cyanin prism of  $28' 30''$  refracting angle. The great dispersive power of the dye is apparent and although the yellow is absent the rest of the curve agrees very well with the dispersion calculated by direct spectrometer readings. The haze in the green is due to diffraction; the angle of the prism was so large that only a very narrow edge was transparent to the green and this produced the ordinary narrow aperture effect.

(d) *The Interferometer Method.*—The previous work has for its basis the deviation of a beam of light by a cyanin prism. The index of refraction can also be found by measuring the retardation produced by a thin film. To make uniform films of cyanin the crystals were dissolved in absolute alcohol and the resulting solution filtered. This solution was then kept in an air-bath at a temperature between  $35^{\circ}$  and  $40^{\circ}$  C. Pieces of plate glass, after being carefully cleaned and heated to the same temperature, were dipped into the solution, and placed on edge to dry in the air-bath. The thickness of the film depends on the concentration of the solution, and as the alcohol evaporates rapidly in the air-bath, films of continually increasing thickness are obtained by dipping in fresh plates from time to time.

To secure good films it is important to use "absolute" alcohol and to keep the temperature inside the given limits throughout the operation. The retardation produced by the film was measured with a Michelson interferometer (F of figure 7), photographs being made of the displaced fringes. The interferometer was illuminated with monochromatic light obtained from the direct vision spectroscope, C, as described in the first part of this paper. From one-half of one of the coated glass plates the cyanin film was carefully removed, the remainder of the film having a straight edge down the center of the plate. This plate, H, was placed between the movable mirror, M, of the interferometer and the half silvered plate, P, with the straight edge of the cyanin film vertical, the instrument having been previously adjusted for horizontal fringes. A plate of clear glass, K, of thickness equal to that of the coated plate was placed in front of the other mirror, L, of the interferometer as a compensator.

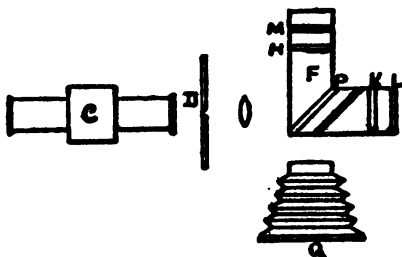

FIG. 7.

The fringes formed by the interference of rays coming through the cyanin were displaced relatively to those formed by rays coming through the clear portion of the plate. In order to facilitate the determination of the displacement the fringes were photographed by means of a camera at Q. The camera was so arranged that by moving the back portion slightly, successive exposures could be made on the same plate, showing the relative displacements of the fringes for all values of  $\mu$  from the extreme red to the ultra violet.

Since the retardation is a function of the wave length, the dis-

placement between the two sets of fringes varies when the wave length of the light used is changed. The light passing through the slit, D, was changed systematically for the successive exposures, so that in the series of photographs shown on plates 21 and 22 a complete record of the retardation throughout the spectrum is secured.

The film (No. I), used in preparing the series shown in figure 1 of plate 21, was very thin (about .00012 mm.) and perfectly transparent throughout the absorption band. The white mark on the sides of the fringe systems was made later to show which pair of fringes belong together. The number given below each exposure is the wave length in  $\mu$  units of the light used in each case.

The series given in figure 2 of plate 21 shows the retardation produced by a somewhat thicker film (about .00017 mm.) not quite as transparent in the region of the absorption band as the first. The third film (No. III), used in the preparation of the first figure of plate 22, was much thicker (about .00071 mm.) and quite opaque for yellow or yellowish green light. Consequently, no fringes were formed in this part of the spectrum by the light passing through the cyanin film.

To continue further into the ultra-violet a Rowland grating was substituted for the spectroscope. Using film No. II, a new series was taken on the blue, violet, and ultra-violet, the results being shown in the second figure of plate 22. Repeating the same series and using film No. III, the photograph shown in figure 3 of the same plate was obtained.

In these photographs it is to be noticed that beyond  $\lambda = 345.6$  no fringes appear. This is due to the absorption of shorter waves by the glass. Further, below  $\lambda = 374.2$ , the intensity of the fringes in both halves of each exposure is practically the same, showing that the cyanin film in this part of the spectrum was perfectly transparent. Between these lines,  $\lambda = 374.2$  and  $\lambda = 345.6$  that part of the light which had the cyanin film in its path is much fainter for the larger waves and disappears altogether before reaching the absorption band in the glass. This corroborates previous observation and proves

conclusively that cyanin has an absorption band in the ultraviolet.

To calculate the refractive index from the photographs shown on plates 21-22, it is necessary to know which pair of lines belong together. With monochromatic light it is impossible to tell whether the displacement is half a fringe or one and a half, or any number of whole fringes more, but if white light is employed and both paths are of equal length there appears a central dark fringe, bordered by about a dozen colored fringes similarly placed with reference to the central dark fringe. This dark fringe is the only one in the whole system that can be identified. Substituting white light in front of slit, D, and having film No. I, on the path of the interferometer, a photograph was taken. The result is shown in *a* in figure 7 of plate 20. When looking at the fringes direct it was plain that the fringes marked on the photograph belonged together. Using film No. II, a photograph seen in *b*, figure 7 (plate 20) was taken. The photograph does not show very plainly which pair of lines go together, but by looking at the fringes directly with the colors present those marked in the figure were easily determined to be part of the same fringe. The third exposure *c* in the same figure was taken with film No. III in the interferometer. The strong absorption of this film made the resulting figure hard to distinguish so that even when the colors were seen directly, it was difficult to tell which was the central dark fringe in the part passing through the cyanin. Several observers, however, independently judged the pair marked in the figure to be correct.

The index of refraction can be found by the usual formula for thin films:—

$$\mu = 1 + \frac{n \lambda}{2e} \quad (33).$$

where  $\mu$  is the index for wave length  $\lambda$ ,  $n$ , the number of fringes by which the central fringe is displaced, and  $e$ , the thickness of the film. The measurement of  $e$  is difficult and the percentage error is large when a film is very thin, as is the case in

these experiments. Therefore, it is desirable to secure a ratio between the indices for the different wave lengths and find the index for some one wave length by another method.

Let  $\mu$  equal index of refraction for  $\lambda$ .

Let  $\mu_1$  equal index of refraction for  $\lambda_1$ .

Let  $n$  equal displacement of fringes for wave length  $\lambda$  in terms of that same wave length.

Let  $n_1$  equal displacement of fringes for wave length  $\lambda_1$  in terms of that same wave length.

Then:  $n \lambda_1 : n \lambda :: \mu - 1 : \mu_1 - 1$ .

Solving for  $\mu_1$  :

$$\mu_1 = 1 + \frac{(\mu - 1) n_1 \lambda_1}{n \lambda} \quad (34).$$

This method is advantageous when the indices for portions of the spectrum, as in the absorption band for cyanin, are difficult to measure by other methods. The displacements  $n$  on the photographs were measured by means of a filar micrometer attached to an eye-piece magnifying about twenty diameters.

Column a in Tables IX-XII gives the width of a fringe, for the given wave length, on the photograph in terms of divisions on the micrometer screw. The width of the displacement in the same units is given in column b. Hence  $\frac{b}{a}$  equals  $n$ , the displacement in terms of fringes of the wave length used.



TABLE IX.

$\lambda$	a	b	n	$n\lambda$	$\mu$
705.5	166.0	82.0	.494	349	2.02
669.5	160.8	100.4	.624	418	2.21
654.9	154.8	103.2	.670	439	2.28
640.1	152.7	107.8	.706	452	2.31
625.8	151.7	104.8	.690	430	2.25
613.2	179.0	84.7	.576	358	2.03
599.8	145.6	74.0	.506	306	1.89
589.6	144.0	59.3	.412	243	1.71
579.0	141.4	52.0	.368	218	1.63
569.5	137.4	42.3	.307	175	1.51
560.7	136.0	28.0	.206	115	1.33
552.4	133.0	24.8	.186	108	1.30
536.9	129.8	12.6	.097	63	1.15
523.3	127.1	16.0	.123	66	1.19
511.0	124.6	20.0	.164	68	1.25
500.0	122.6	28.6	.233	117	1.34
490.5	119.5	33.5	.280	137	1.39
480.9	117.4	34.2	.291	141	1.41
473.6	115.6	37.6	.326	154	1.45
466.1	113.9	39.3	.349	163	1.47
460.5	113.2	40.2	.355	165	1.48
453.0	111.5	42.6	.381	173	1.50
445.0	110.1	44.0	.399	178	1.52
438.0	107.3	48.0	.447	194	1.55
422.9	103.0	51.0	.495	209	1.59
414.8	101.6	51.8	.501	211	1.61
409.1	100.4	52.0	.513	212	1.62
399.8	97.9	52.2	.523	213	1.62
394.5	98.0	52.4	.525	213	1.62
392.1	97.7	54.0	.551	216	1.63

TABLE X.

$\lambda$	a	b	n	$n\lambda$	$\mu$
492.5	129.9	36.6	.281	142	1.39
464.8	119.9	48.6	.405	142	1.52
436.5	110.5	49.2	.448	194	1.54
407.8	106.5	60.2	.565	230	1.62
390.0	101.8	63.2	.620	238	1.65
374.2	99.3	67.8	.701	262	1.70
368.5	97.5	70.0	.718	264	1.73
364.6	96.9	71.0	.732	267	1.74
362.7	96.1	72.1	.750	271	1.75
357.5	92.6	73.0	.770	275	1.76

The two photographs used for tables IX and X were taken with the same cyanin film in one path of the interferometer. The relation between  $\mu$  and  $\lambda$  as given in tables IX and X is shown graphically in the curve of plate 17 by the full line, while the dispersion curve obtained by direct spectrometer readings is indicated by the broken line. These curves, obtained by entirely independent methods, agree very well, and the difference is probably due to a change in the properties of the substance in the two conditions, for the cyanin was fused in the one case and deposited from an alcoholic solution in the other. It is important to note the rapid rise in the curve when the absorption band in the ultra violet is approached, as it shows a similarity to the increase in the refractive index as the absorption band in the yellow is approached from the red end of the spectrum.

The results from measurements made on the photograph shown in figure 1 of plate 22 are given in table XI.

TABLE XI.

$\lambda$	a	b	n	$n\lambda$	$\mu$
705.5	196.0	442.0	2.26	159	2.11
669.5	182.2	490.2	2.68	179	2.25
654.9	177.1	517.4	2.92	191	2.34
640.1	173.4	528.0	3.10	196	2.38
628.3	168.7	52.8	0.576	301	1.21
511.0	138.0	114.0	0.826	422	1.29
500.0	135.6	125.2	0.966	498	1.35
490.5	134.6	151.6	1.125	553	1.38
480.9	129.6	160.6	1.239	596	1.42
478.6	125.0	161.4	1.290	611	1.43
466.1	124.6	169.2	1.367	632	1.44
460.2	124.4	178.0	1.424	655	1.46
453.0	125.2	185.4	1.480	671	1.47
445.0	126.0	188.0	1.480	664	1.47
443.0	123.3	194.0	1.570	697	1.49
422.9	116.4	197.0	1.687	718	1.50
444.8	114.0	201.0	1.760	781	1.51
409.1	110.0	204.0	1.830	770	1.54
364.3	106.0	207.4	1.970	778	1.55
362.1	104.9	213.2	2.030	795	1.55

For figure 2 of plate 22 the readings and calculated results are given in table XII.

TABLE XII.

$\lambda$	a	b	n	$n\lambda$	$\mu$
492.5	144.7	197.8	1.36	672	1.40
464.8	132.3	224.6	1.69	789	1.47
436.5	119.2	241.6	2.02	882	1.53
407.8	113.6	245.2	2.16	880	1.53
380.0	111.6	254.2	2.23	865	1.52
374.2	109.9	257.6	2.29	857	1.52
363.5	107.4	262.0	2.44	899	1.54
364.6	105.5	266.0	2.52	923	1.55
362.7	104.2	269.9	2.59	940	1.56

The two photographs used for tables XI and XII were taken when cyanin film No. III was in one path of the interferometer. The relation between  $\mu$  and  $\lambda$ , as given by tables XI and XII, is shown graphically by the line in plate 18, while the broken line represents the results obtained by direct spectrometer readings. The fringes in figure 1 of plate 22 are not quite parallel, and hence the errors in measuring  $a$  and  $b$  are larger, therefore the results for this film are not as good as for film No. II.

*Conclusion.*—It was originally intended to attempt a more rigorous proof of the Ketteler-Helmholtz dispersion formula, by using more accurately determined values of the refractive indices of cyanin for waves of various lengths. Pfüger's work while confirming the formula for the visible part of the spectrum, showed discrepancies in the ultra violet and extreme red. He suggests that these discrepancies, at least in the ultra violet, may be caused by the presence of an ultra violet absorption band. This band has unquestionably been found, but until its characteristics have been more thoroughly determined (a matter requiring a large amount of further experimental work) any attempt to apply the new values to the formula would be useless.

The most important results which have been obtained by this work may be summarized as follows:

1st. A fairly accurate determination of the dispersion curve for cyanin from the extreme red well into the ultra violet.

2d. The conclusive evidence furnished by the photographs taken with the interferometer, of the continuity of the curve through the absorption band of cyanin.

3d. The discovery of a new absorption band in the ultra violet spectrum of cyanin, the character of which will have to be accurately determined before any conclusive proof of the Ketteler-Helmholtz dispersion theory can be furnished by measurements upon this substance.

This work was undertaken two years ago, at the suggestion of Professor R. W. Wood, and is a continuation of a series of

experiments made by him in the previous year. The experiments have been performed under his direction, and I take this opportunity to acknowledge indebtedness to him for many ideas and suggestions and for much assistance.

---

## BIBLIOGRAPHY.

### THE DISPERSION OF LIGHT.

- 1746-1866. E. VERDET, "Leçons d'optique physique." Vol. II., 37-40.
1868. R. A. MEES, "Ueber die von C. Briot aufgestellte Dispersionstheorie." Pogg. Ann. CXXIV., 118-146; Mondes, XVIII., 303-305; Fort. d. Phys. XXIV., 260.
1868. C. BRIOT, "Sur les vibrations intérieures des molécules." Louisville J. XIII., 304-312; Fort. d. Phys. XXIV., 264.
1868. E. MATHIEU, "Sur la dispersion de la lumière." Ann. de Chim. (4), X., 128-136; Fort. d. Phys. XXIV., 274.
1869. CHALLIS, "Comparison of a theory of dispersion of light on the hypothesis of undulations with Ditscheiner's determinations of wave lengths and corresponding refracting indices." Phil. Mag. (4), XXXVIII., 268-281.
1869. RICOUR, "Sur la dispersion de la lumière." C. R. LXIX., 1231-1233; Fort. d. Phys. XXV., 281.
1869. VAN DER WILLIGEN, "Sur la dispersion." Musée Teyler II., (4), 308-315; Fort. d. Phys. XXV., 293.
1870. RICOUR, "Sur la dispersion de la lumière." C. R. LXX., 115-119; Mondes, (3), XXII., 185-186; Franklin J. LXI., 48.

1870. E. KETTELER, "Ueber den Einfluss der ponderablen Molekülen auf die Dispersion des Lichtes und über die Bedeutung der Constanten der Dispersionsformeln." *Pogg. Ann.* CXL., 1-53; 117-219; *Ann. de Chim.* (4), XXV., 221-227.
1870. W. WERNICKE, "Ueber die Brechungsindices und die Dispersion undurchsichtiger Körper." *Pogg. Ann.* CXXXIX., 132-150; *Ann. de Chim.* (4), XX., 220-222; *Mondes*, (2), XXIII., 367-370; *Phil. Mag.* (4), XL., 105-117.
1870. W. GIBBS, "On a liquid of high dispersive power." *Phil. Mag.* (4), XL., 229-231; *Mondes*, (2), XXV., 133-135.
1870. C. CHRISTIANSEN, "Ueber das Brechungsverhältniss des Fuchsins." *Pogg. Ann.* CXXI., 479-480; CXLIII., 250-259; *Ann. de Chim.* (4), XXV., 213-214, 400-403.
1871. A. KUNDT, "Ueber die anomale Dispersion der Körper mit Oberflächenfarben." *Pogg. Ann.* CXLII., 163-171; *Cimento*, (2), IV., 282-284; *Nachtrag*, *Pogg. Ann.* CXLIII., 149-152.
1871. A. KUNDT, "Ueber anomale Dispersion." *Pogg. Ann.* CXLIII., 259-269.
1871. A. KUNDT, "Ueber anomale Dispersion." *Pogg. Ann.* CXLIV., 128-137; *Mondes*, (2), XXV., 142-144; *Ann. de Chim.* (4), XXV., 400-403; 409-410; 413-418.
1871. J. L. SORET, "Ueber die anomale Dispersion einiger Substanzen." *Pogg. Ann.* CXLIII., 325-327.
1871. V. V. LANG, "Ueber die anomale Dispersion spitzer Prismen." *Pogg. Ann.* CXLIII., 269-272; *Ann. de Chim.* (4), XXV., 410-412, 418-421; *Mondes*, (2), XXIV., 445.
1871. W. SELLMEIER, "Zur Erklärung die abnormen Farbenfolge im Spektrum einiger Substanzen." *Pogg. Ann.* CXLIII., 272-288.

1872. W. SELLMEIER, "Ueber die durch die Aetherschwingungen erregten Mitschwingungen der Körpertheilchen und deren Rückwirkung auf die ersteren besonders zur Erklärung der Dispersion und ihrer Anomalien." Pogg. Ann. CXLV., 399-421, 520-521; CXLVII., 385-403, 525-554.
1872. O. E. MEYER, "Versuch einer Erklärung der anomalen Farbenzerstreuung." Pogg. Ann. CXLV., 80-86; Phil. Mag. (4), XLIII., 295-299; Ann. de Chim. (4), XXV., 423.
1872. C. CHRISTIANSEN, "Zur Farbenzerstreuung des Fuchsin." Pogg. Ann. CXLVI., 154-155.
1872. A. KUNDT, "Ueber anomale Dispersion." Pogg. Ann. CXLV., 67-80, 164-166; Ann. de Chim. (4), XXV., 419-421; Nature, VI., 130-131.
1872. J. L. SORET, "Sur la dispersion anormale." Arch. sc. phys. (2), XLIV., 81-84.
1872. H. F. TALBOT, "Note on some anomalous spectra." Proc. Edin. Soc. VII., 408-410; Mondes, (2), XXVIII., 428-430.
1873. MOUSSON, "Méthode pour mesurer la dispersion dans les différentes parties du spectre." Nature, VII., 9; Arch. sc. phys. (2), XLV., 13; Pogg. Ann. CXLVIII., 660.
1873. G. PERRY, "Sur la variabilité des coefficients de l'élasticité et la dispersion." C. R. LXXVI., 501-505; Mondes, XXX., 442.
1873. C. PUSCHL, "Ueber den Zusammenhang zwischen Absorption und Brechung des Lichtes." Wiener Berichte (2), LXVII., 4-7; Mondes, (2), XXX., 594-595; Chem. C. Bl. (1873), 161-162.
1874. E. KETTELER, "Das spezifische Gesetz der sogenannten anomalen Dispersion." Pogg. Ann. Jubelband, 166-182.
1874. MASCART, "Sur la dispersion des gaz." C. R. LXXVIII., 679-682.

1874. H. V. HELMHOLTZ, "Zur Theorie der anomale Dispersion." Berl. Monatsber. (1874), 667-680.
1874. LUNDQUIST, "Sur la reflexion de la lumière à la surface des corps isotropes." Nov. Act. Ups. IX., H. 1. 1-54; Pogg. Ann. CLII., 177-200, 398-413, 565-596.
1875. W. WERNICKE, "Ueber die Absorption und Brechung des Lichtes in metallisch-undurchsichtigen Körpern." Pogg. Ann. CLV., 87-95.
1875. L. MATHIESEN, "Ueber die Dispersion der Farben in Gasen." Z. S. für Math. u. Phys. XX., 92-96.
1875. L. LORENZ, "Experimentale og theoretiske Undersøgelser over Legemernes Brydningsforhold." Vidensk. Selsk. Skr. (5), No. 8, X., 485-518.
1876. E. KETTELER, "Versuch einer Theorie der (anomalen) Dispersion des Lichtes in einfach und doppelt brechenden Mitteln." Carl's Rep. XII., 322-361; Phil. Mag. (5), II., 332-345, 413-421, 508-522.
1876. E. KETTELER, "Zur Theorie der Dispersion und Absorption des Lichtes in doppeltbrechenden Mitteln." Pogg. Ann. Erg. VIII., 444-474.
1876. W. WERNICKE, "Ueber die Bestimmung der Constanten für die Absorption des Lichtes in metallischen Silber." Pogg. Ann. Erg. VIII., 65-82.
1877. E. KETTELER, "Zum Zusammenhang zwischen Absorption und Dispersion." Pogg. Ann. CLX., 466-486.
1877. HURION, "Recherches sur la dispersion anormale." Ann. de l'école normale (2), VI., 367-412; Beibl. (1878), 79-86.
1877. E. LOMMEL, "Theorie der normale und anomale Dispersion." Ann. d. Phys. (2), III., 339-356.
1878. E. KETTELER, "Das Dispersionsgesetz." Wied. Ann. (2), VII., 658-670.
1878. E. LOMMEL, "Ueber eine zweiconstantige Dispersionformel." Wied. Ann. (2), VIII., 628-634; Carl's Rep. XV., 768-770.



1878. G. SCHEBUJEFF, "Zur Dispersionstheorie des Lichtes." Journ. d. russ. Phys. Chem. Ges. XI., Phys. Theil, p. 103.
1878. G. SIEBEN, "Untersuchungen über die anomale Dispersion des Lichtes." Wied. Ann. VIII., 137-157.
1879. THOLLON, "Minimum de dispersion des prismes; achromatisme de deux lentilles de même substance." C. R. LXXXIX., 93-96.
1879. A. LOMENI, "Bemerkungen über die Bestimmung der Dispersionconstante." Beibl. III., 272-273.
1879. DE KLERCKER, "Ueber das anomale Spektrum des Lichtes." C. R. LXXXIX., 734-736. Beibl. IV., 273. Phil. Mag. (5), VIII., 521-572.
1880. E. KETTELER, "Das Dispensionsgesetz." Carl's Rep. XXI., 221-231; Fort. d. Phys. XXXVI., 379.
1880. O. HESSE, "Untersuchungen über das Dispensionsgesetz." Fort. d. Phys. XXXVI., 381; Wied. Ann. XI., 871-908.
1881. E. LOMMEL, "Ueber das Dispensionsgesetz." Wied. Ann. (2), XIII., 353-360.
1881. E. KETTELER, "Einige Anwendungen des Dispensionsgesetz auf durchsichtige, halbdurchsichtige und undurchsichtige Mittel." Fort. d. Phys. XXXVII., 375; Wied. Ann. (2), XII., 363-380.
1882. GUOY, "Sur la propagation des ondes lumineuses en égard à la dispersion." Fort. d. Phys. XXXVIII., 25; Journ. de Math. (3), VIII., 335-336.
1882. DE KLERCKER, "Untersuchungen über die prismatische Dispersion des Lichtes." Fort. d. Phys. XXXVIII., 38. Bihang Sv. Vet. Akad. Handl. VII., 1-55.
1882. A. WUELLNER, "Zur Dispersion farblos durchsichtiger Medien." Wied. Ann. XVII., 580-587; Fort. d. Phys. XXXVIII., 39.

1882. V. v. LANG, "Bestimmung der Brechungsexponenten einer concentrirter Cyaninlösung." Wien. Ber. (2), LXXXIV., 361-380; Fort. d. Phys. XXXVIII., 40.
1882. G. SIEBEN, "Untersuchung über die anomale Dispersion des Lichtes in concentrirten alkoholischen Cyaninlösungen." Carl's Rep. XVIII., 737-747; Fort. d. Phys. XXXVIII., 40.
1882. PULFRICH, "Bestimmung des Brechungsquotienten einer concentrirten Cyaninlösung." Wied. Ann. XVI., 335-348. Fort. d. Phys. XXXVIII., 40.
1882. C. CHRISTIANSEN, "Ueber die Messung des Brechungsverhältnisses gefärbter Flüssigkeiten." Nature, XXVIII., 308. Wied. Ann. XIX., 256-267; Fort. d. Phys. XXXVIII., 42.
1883. E. KETTELER, "Optische Controversen." Wied. Ann. XVIII., 387-421, 631-663.
1883. W. VOIGT, "Ueber die Grundgleichungen der optischen Theorie des Hrn. E. Ketteler." Wied. Ann. XIX., 691-704; Fort. d. Phys. XXXIX., 11.
1883. E. LOMMEL, "Zur Theorie des Lichtes." Wied. Ann. XIX., 908-914.
1883. W. VOIGT, "Zur Theorie des Lichtes." Wied. Ann. XX., 444-452.
1883. L. LORENZ, "Theorie der Dispersion." Wied. Ann. XX., 1-21.
1883. DE KLERCKER, "Recherches sur la dispersion de la lumière." C. R. XCVII., 707-708. L. Electrician, XI., 555.
1884. W. VOIGT, "Ueber die Theorie der Dispersion und Absorption speciell über die optischen Eigenschaften des festen Fuchsins." Fort. d. Phys. XL., 19; Wied. Ann. XXIV., 144-156.
1884. E. KETTELER, "Zur Dispersionstheorie des Lichts." Wied. Ann. (2), XXI., 199-208; Fort. d. Phys. XL., 28.
- "Zur Dispersion des Quarzes." Wied. Ann. (2), XXI., 438-452.

1884. P. JAERISCH, "Dispersionstheorie." Fort. d. Phys. XL., 30. Hamb. Mitth., 59-60.
1884. G. SIEBEN, "Ueber die Abhängigkeit der Brechungsexponenten anomal dispergirender Medien von der Concentration der Lösung und der Temperatur." Wied. Ann. XXIII., 312-343.
1885. R. T. GLAZBROOK, "Report on Optical Theories." Brit. Assoc. (1885), 157-162; Nature, XXXIII., 18-20.
1885. E. KETTELER, "Theoretische Optik." Beibl. IX., 763.
1886. J. W. BRUEHL, "Experimentelle Prüfung der älteren und der neueren Dispersionformeln." Beibl. XI., 244 (1887). Chem. Ber. XIX., 2821-2837; Fort. d. Phys. XLII., 33.
1887. F. KOLACEK, "Versuch einer Dispersionserklärung vom Standpunkte der elektromagnetische Lichttheorie." Wied. Ann. XXXII., 244-255, 429-439.
1887. E. KETTELER, "Zur Handhabung der Dispersionsformeln." Wied. Ann. XXX., 299-316; Jour. de Phys. (2), VII., 130-131.
- "Zur Dispersion des Steinsalzes." Wied. Ann. XXXI., 322-326; Jour. d. Phys. (2), VII., 131-132.
1887. A. WINKELMANN, "Notiz zur anomale Dispersion glühender Metaldämpfe." Wied. Ann. XXXII., 439-442; Jour. d. Phys. (2), VII., 132 (1888).
1888. F. KOLACEK, "Beiträge zur electromagnetische Lichttheorie." Wied. Ann. XXXIV., 673-711.
1888. R. T. GLAZBROOK, "On the application of Sir William Thomson's Theory of a Contractile Aether to Double Refraction, Dispersion, Metallic Reflexion, and other Optical Problems." Phil. Mag. XXVI., 521-540.
1888. E. WILSON, "The Law of Dispersion." Phil. Mag. XXVI., 385-389.
1890. A. BREUER, "Uebersichtliche Darstellung der mathematischen Theorien der Dispersion des Lichtes." Hannover, Bachmeister, 50 pp. Beibl. XIV., 971.

1890. A. WINKELMANN, "Zur anomale Dispersion gefärbter Gläser." Wied. Ann. XL., 661.
1891. W. VOIGT, "Zur Theorie des Lichtes." Wied. Ann. XLIII., 412.
1892. D. A. GOLDHAMMER, "Die Dispersion und Absorption des Lichtes nach der electrischen Lichttheorie." Wied. Ann. XLVII., 93.
1892. A. BREUER, "Uebersichtliche Darstellung der math. Theorien über die Dispersion des Lichtes." II. Theil, "Anomale Dispersion." Beibl. XVI., 273. Erfurt, Bachmeister, 54 pp.
1893. H. V. HELMHOLTZ, "Electromagnetische Theorie der Farbenzerstreuung." Wied. Ann. XLVIII., 389, 723; London Electrician, XXXVII., 404 (1896).
1893. E. KETTELER, "Notiz, betreffend die Möglichkeit einer zugleich den elastische-optischen wie den electromagnetischen Principien entsprechenden Dispersionsformel." Wied. Ann. XLIX., 382.
1893. S. BLOCH, "Sur la dispersion anormale." Beibl. XVII., 1046; C. R. CXVI., 746-748.
1893. H. KAYSER, und C. RUNGE, "Dispersion der Luft." Wied. Ann. L., 293.
1893. DU BOIS, "Brechung und Dispersion der Metalle." Wied. Ann. XLVIII., 785.
1894. F. PASCHEN, "Die Dispersion des Fluorits und die Ketteler'sche Theorie der Dispersion." Wied. Ann. LIII., 812, 301, 337.
1894. H. RUBENS, "Prüfung der Ketteler-Helmholtz'schen Dispersionsformel." Wied. Ann. LIII., 267; LI., 381.
1894. H. TH. SIMON, "Dispersion ultraviolettes Strahlen." Wied. Ann. LIII., 542.
1895. H. RUBENS, "Die Ketteler-Helmholtz'sche Dispersionsformel." Wied. Ann. LIV., 476.
1895. R. REIFF, "Zur Dispersionstheorie." Wied. Ann. LV., 82.

1895. FRANTZ DE COLNET D'HUART, "Ausdehnung der Maxwell'schen Gleichungen auf die Dispersion." Beibl. XIX., 58.
1896. A. PFLUEGER, "Anomale Dispersionkurve einige fester Farbstoffe." Wied. Ann. LVI., 412.
- "Zur anomale Dispersion absorbirender Substanzen." Wied. Ann. LVIII., 670.
1896. B. WALTERS, "Ueber die Brechungsexponenten des festen Fuchsin." Wied. Ann. LVII., 394.
1898. O. HEAVISIDE, "Dispersion." London Electrician, XXXVII., 470.
1898. A. PFLUEGER, "Prüfung der Ketteler-Helmholtz'schen Dispersionsformeln an den optischen Konstanten anomaldispersirender, fester Farbstoffe." Wied. Ann. LXV., 173-225.
- "Prüfung der Cauchy'schen Formeln der Metallreflexion an den optischen Konstanten des festen Cyanins." Wied. Ann. LXV., 225.
1898. R. W. WOOD, "The Anomalous Dispersion of Cyanin." Phil. Mag. XLVI., 380-386.
1898. J. H. VINCENT, "On the Construction of a Mechanical Model to Illustrate Helmholtz's Theory of Dispersion." Phil. Mag. XLVI., 557.
1899. LORD RAYLEIGH, "The Theory of Anomalous Dispersion." Phil. Mag. XLVIII., 151-152.

# PLATES.



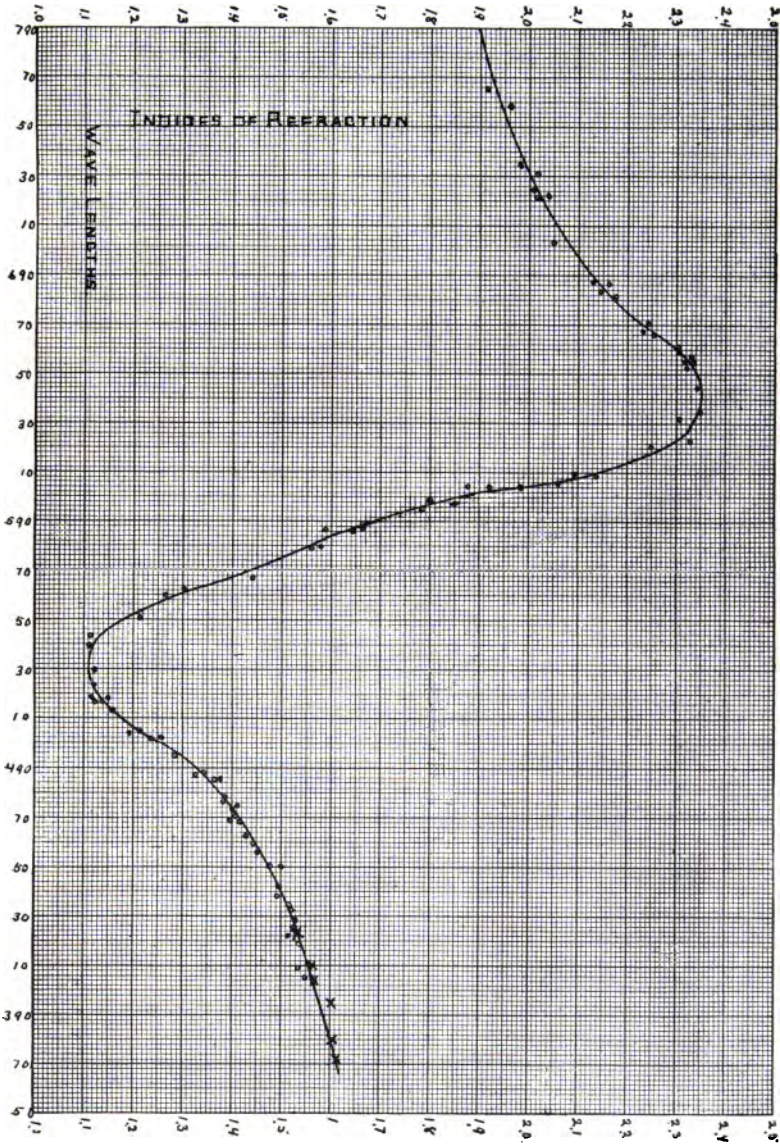





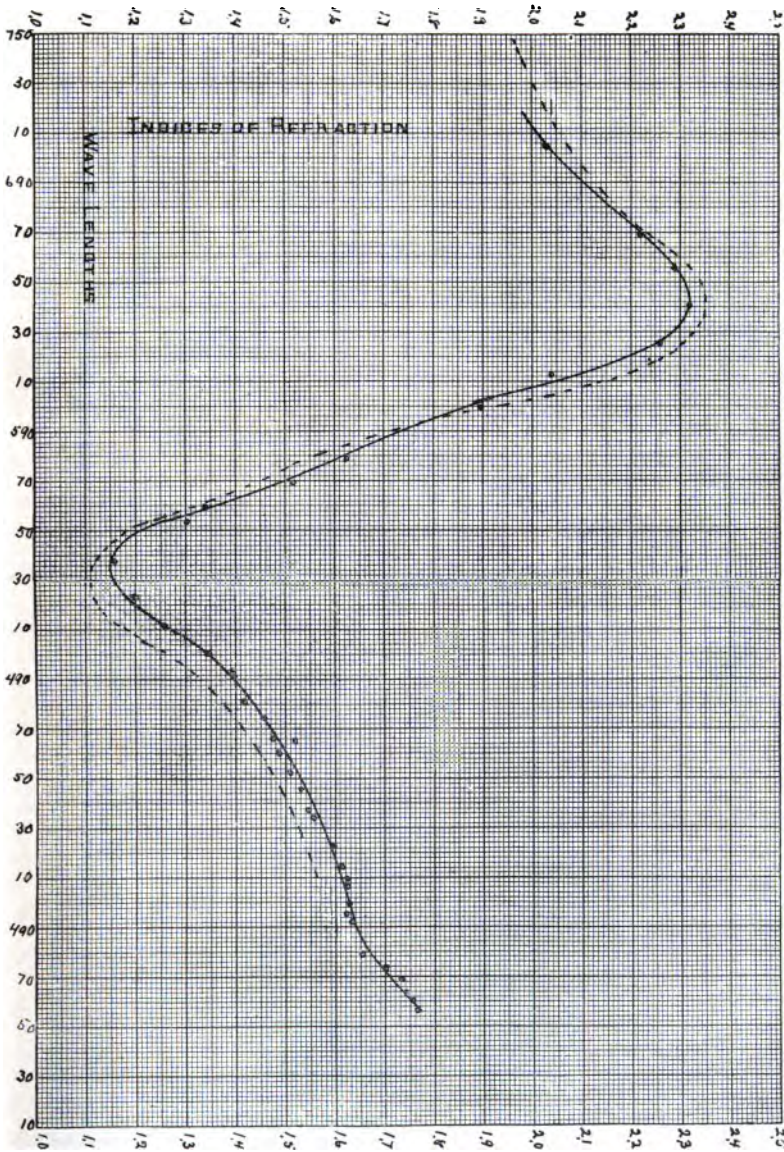



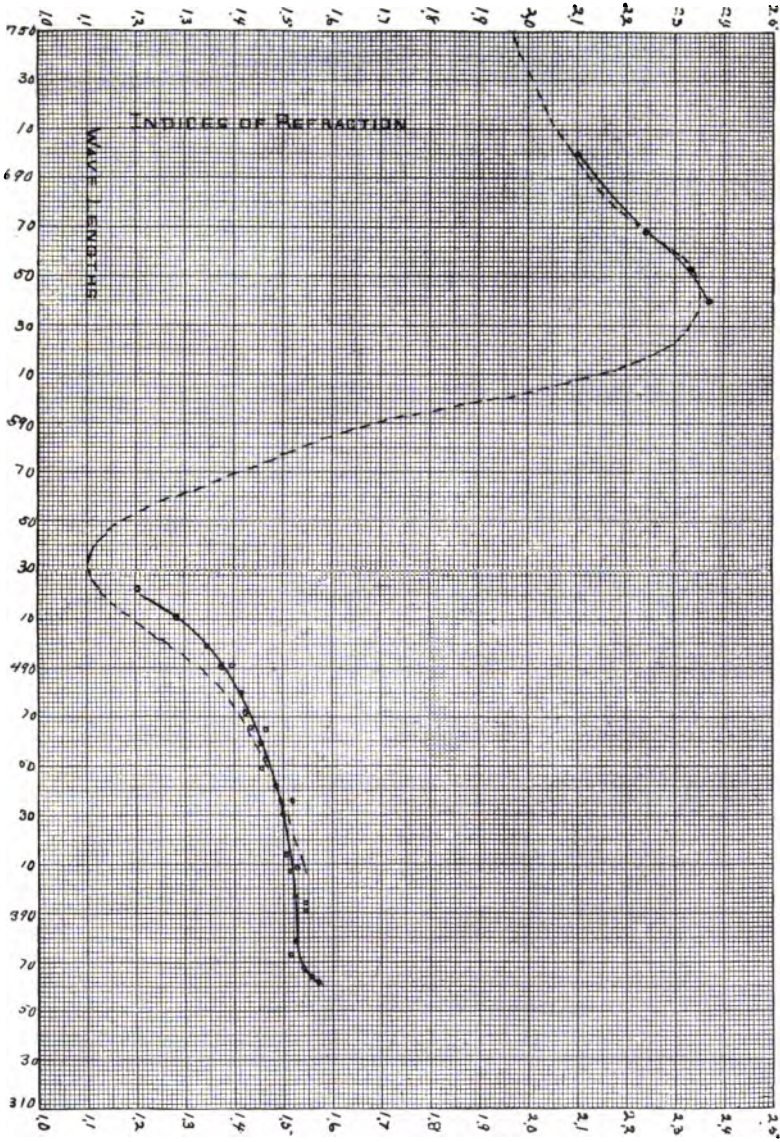



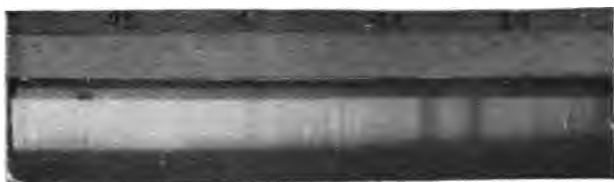

1

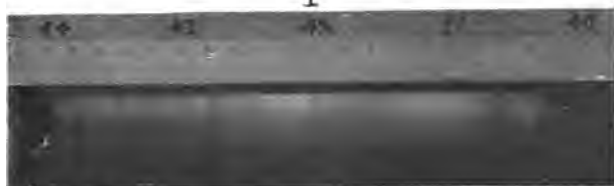

2



3

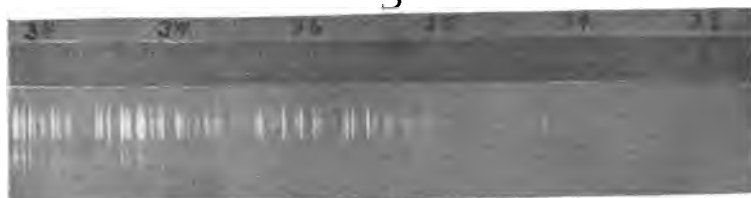

4



5



6





1



2



3



4



5



6

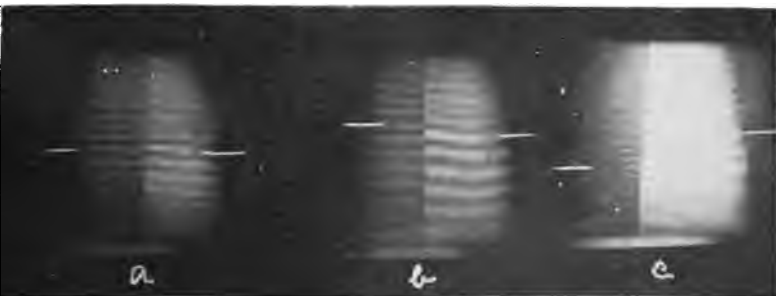

7





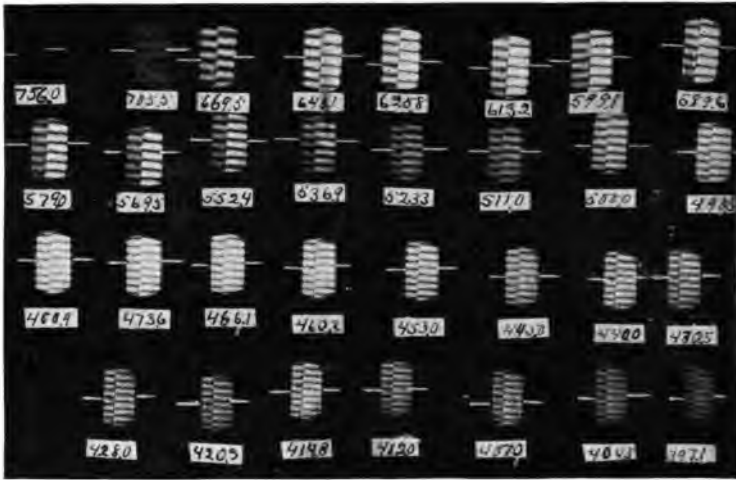

1.

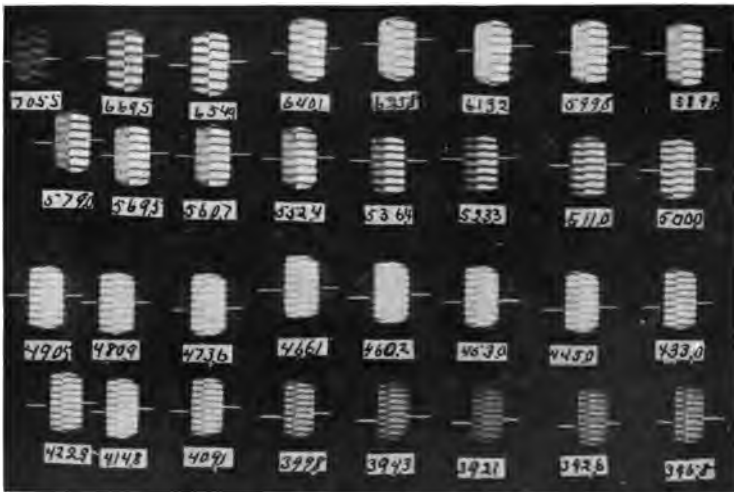

2.



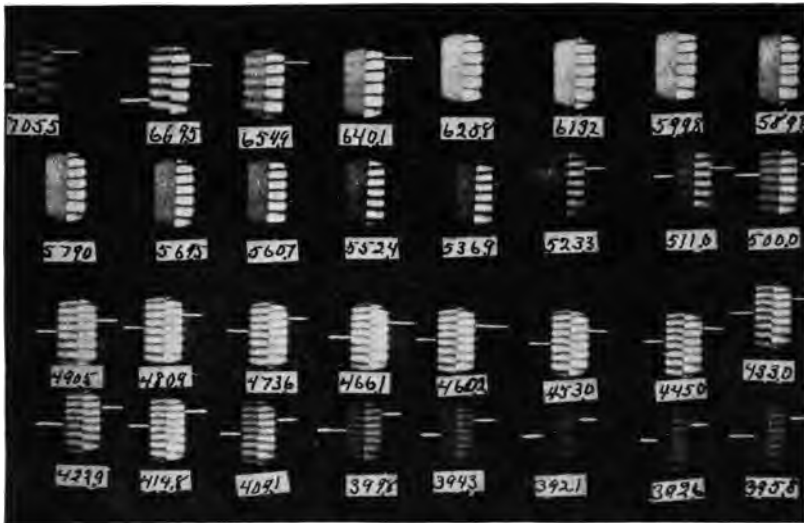

1



2

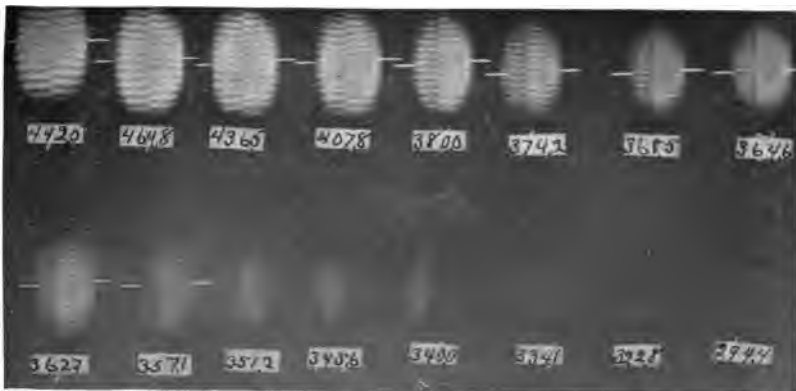

3















89081793085



B89081793085A



89081793085



b89081793085a